



Glori ir Ko

PRODUCT CATALOGUE

SHEET METAL PRODUCTS

Letter boxes

Manifold cabinets

Weathervanes

Flower pot brackets

Access panels

Flat ventilation ducts

Firewood trolley on wheels

Pellet storage bin

Other products





TABLE OF CONTENT

| | |
|-----------|----------------------------|
| 4 | About us |
| 6 | Apartment letter-boxes |
| 13 | Individual letter-boxes |
| 17 | Weathervanes |
| 20 | Flower pot brackets |
| 22 | Access panels |
| 29 | Manifold cabinets |
| 30 | Flat ventilation ducts |
| 32 | Firewood trolley on wheels |
| 33 | Pellet storage bin |
| 35 | Other products |
| 40 | Contacts |

WE ARE



Glori ir Ko

manufacturing company specializing in:
various articles made of sheet metal,
powder coating of metal surfaces.

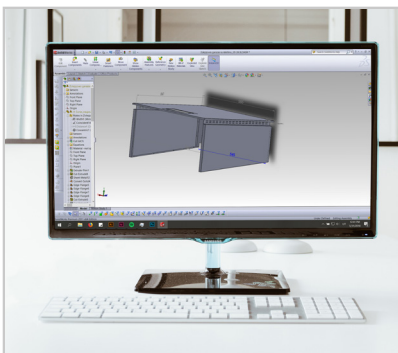

ENGINEERING AND DESIGN

The company "Glori ir Ko" has accumulated 25 years of experience. Our engineers are designing and preparing various articles of sheet metal for a serial production.

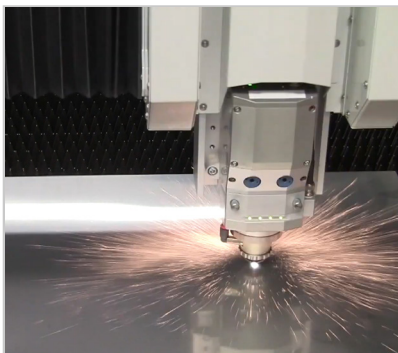

PRECISE SHEET METAL PRODUCTION

UAB 'Glori ir Ko' is producing precise parts of sheet metal using CNC Turret Punching, Programmable Folding Machine, CNC Laser Cutting and other technologies.



IMPECCABLE PAINTING QUALITY

In order to ensure high quality and aesthetic surface, separate parts of the products are coated by metal phosphate solution, this way increasing adhesiveness of paint and preventing from corrosion. Afterwards, the washed parts are polyester powder paint coated.



ERP SYSTEM

We have implemented ERP system to ensure production management and accounting quality.

FACILITIES

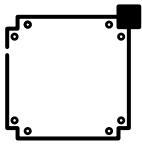

CNC stamping

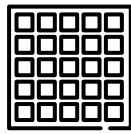

CNC perforation



Riveting

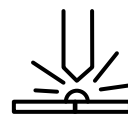

Welding

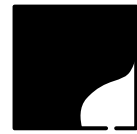

Powder coating

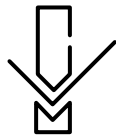

CNC edge bending press

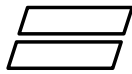

Sheet metal shearing

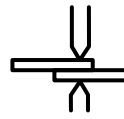

Contact welding



Bolt welding

Since
1993 M.

many products are
exported to

16

different countries.

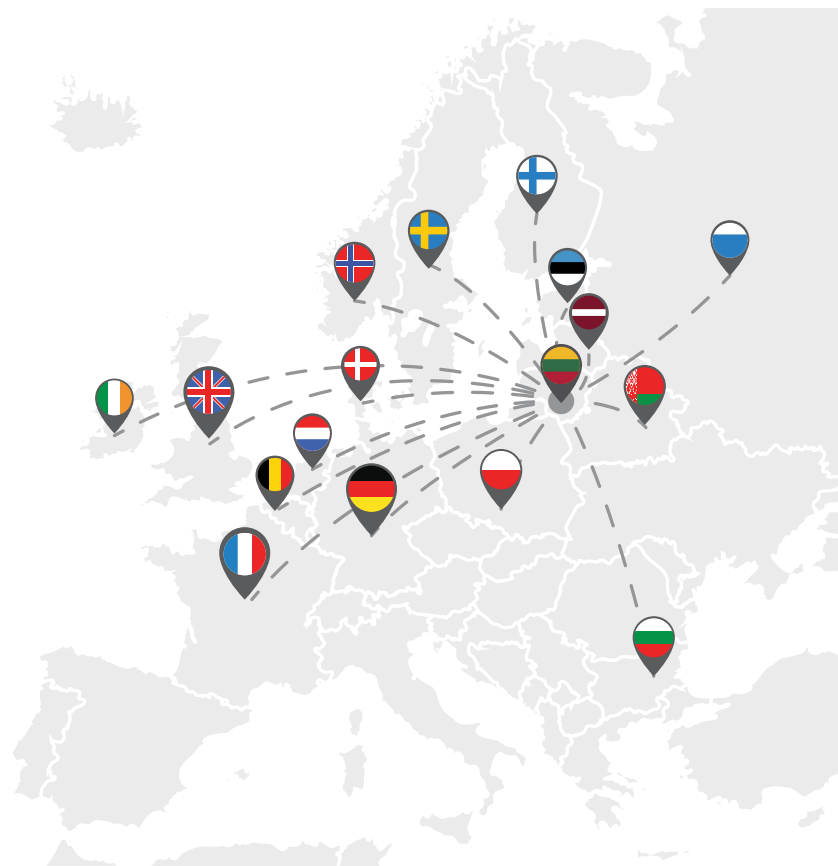

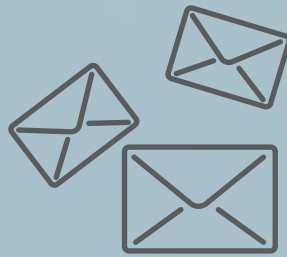

APARTMENT LETTER-BOXES

DURABLE AND HIGH QUALITY

Fine and aesthetic, horizontally joint (multiple) indoors letter-boxes are made of zinc-galvanized sheet metal and polyester powder paint coated. There is a slot for a house number, a title or a surname on most of the letter-boxes.

GENERAL INFORMATION

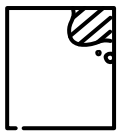

Zinc-galvanized, powder paint coated metal not only prevents a letter-box from corrosion, but adds to it an 'eye-catching' look.



Secure locking mechanism. Two keys are added to each letter-box.

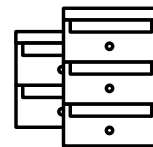

Wide range and versatility in colour and size.

There is designated slot for a house number, a title or a surname on most of the letter-boxes.

Paper flat numbers are complementary issued upon a request.



STANDARD COLOR CODES

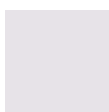

RAL 9006



RAL 8017



RAL 7032



RAL 7016



RAL 9005



RAL 9016

Certain quantities of the multiple letter-boxes in silver/grey colour (RAL 9006) are maintained in company's warehouse. The products are painted in different colours upon a request too.

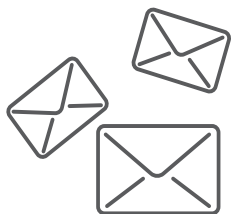

APARTMENT LETTER-BOX PDL91

Suitable for outdoors.
Mail insert flap and enlarged
roof makes it waterproof / rain resistant.



A letter-box is either a wall or a
mount-support / stand attachable. A
range of the company's stands are
listed on **page 11**.

OPTIONS



With stainless
steel doors



DIMENSIONS (MM)

| Code | Quantity of places | X | Y | Z |
|--------|--------------------|-----|------|-----|
| PDL912 | 2 | 390 | 382 | 260 |
| PDL913 | 3 | 390 | 494 | 260 |
| PDL914 | 4 | 390 | 606 | 260 |
| PDL915 | 5 | 390 | 718 | 260 |
| PDL916 | 6 | 390 | 830 | 260 |
| PDL917 | 7 | 390 | 942 | 260 |
| PDL918 | 8 | 390 | 1054 | 260 |
| PDL919 | 9 | 390 | 1166 | 260 |
| PDL911 | 10 | 390 | 1278 | 260 |

2 TO 10 COLLECTIVE DELIVERY POINTS



PD912



PD913



PD914



PD915



PD916



PD917



PD918



PD919



PD911

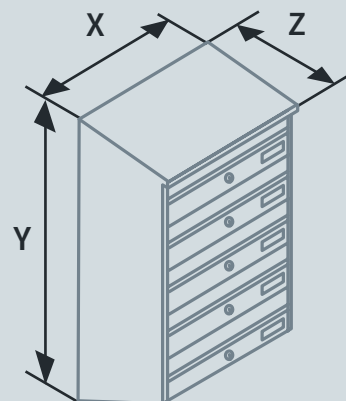

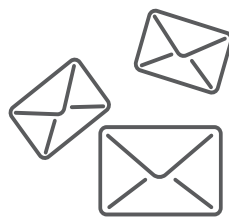

APARTMENT LETTER-BOX PDV93

Suitable for multi-residential houses.
The letter-box is only 145 mm thick,
thus space saving.

DIMENSIONS (MM)

| Code | Quantity of places | X | Y | Z |
|--------|--------------------|-----|------|-----|
| PDV932 | 2 | 385 | 388 | 145 |
| PDV933 | 3 | 385 | 500 | 145 |
| PDV934 | 4 | 385 | 612 | 145 |
| PDV935 | 5 | 385 | 724 | 145 |
| PDV936 | 6 | 385 | 836 | 145 |
| PDV937 | 7 | 385 | 948 | 145 |
| PDV938 | 8 | 385 | 1060 | 145 |
| PDV939 | 9 | 385 | 1172 | 145 |
| PDV931 | 10 | 385 | 1284 | 145 |

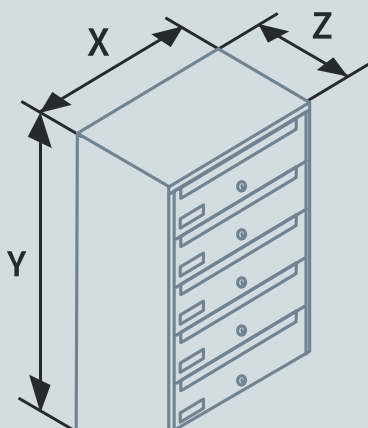

OPTIONS



With stainless steel doors



Other colour combinations available upon a request.

2 TO 10 COLLECTIVE DELIVERY POINTS



PD932

PD933

PD934

PD935



PD936

PD937

PD938

PD939

PD931



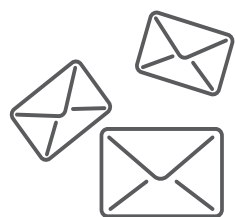

APARTMENT LETTER-BOX PDV94



Horizontal letter-box.
An optimal choice for the staircase
premises of the multi-flat houses.
Robust and capacious.

OPTIONS



Single coloured
letter-boxes.



Two-coloured
letter-boxes.

DIMENSIONS (MM)

| Code | Quantity of places | X | Y | Z |
|--------|--------------------|------|-----|-----|
| PDV942 | 2 | 420 | 400 | 131 |
| PDV943 | 3 | 620 | 400 | 131 |
| PDV944 | 4 | 820 | 400 | 131 |
| PDV945 | 5 | 1020 | 400 | 131 |

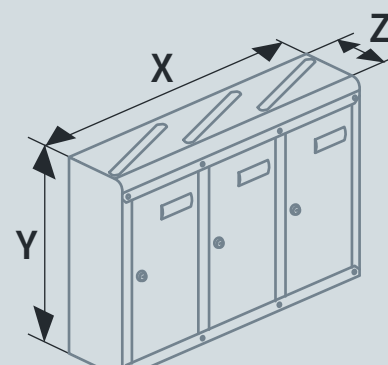

2 TO 5 COLLECTIVE DELIVERY POINTS



PD942



PD943



PD944



PD945

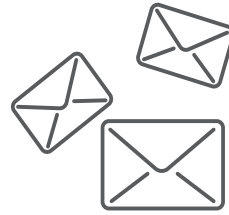

APARTMENT LETTER-BOX PDV96

Suitable for the multi-flat houses.
Exceptionally thin, yet capacious.

DIMENSIONS (MM)

| Code | Quantity of places | X | Y | Z |
|--------|--------------------|-----|-----|-----|
| PDV962 | 2 | 336 | 400 | 122 |
| PDV963 | 3 | 336 | 540 | 122 |
| PDV964 | 4 | 336 | 680 | 122 |
| PDV965 | 5 | 336 | 820 | 122 |
| PDV966 | 6 | 336 | 960 | |

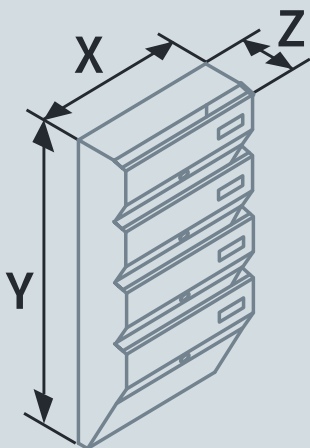

THE PRODUCTS ARE
PAINTED IN DIFFERENT
COLOURS UPON A
REQUEST TOO.

2 TO 6 COLLECTIVE DELIVERY POINTS



PD962



PD963



PD964



PD965



PD966



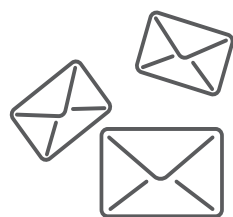

TWO-SIDED APARTMENT LETTER-BOX PDD 92

Double-faced letter-box mountable either into the wall or a fence.



DIMENSIONS (MM)

| Code | Quantity of places | X | Y | Z |
|--------|--------------------|-----|-----|-----|
| PDD922 | 2 | 395 | 452 | 200 |
| PDD923 | 3 | 395 | 585 | 200 |
| PDD924 | 4 | 395 | 719 | 200 |
| PDD925 | 5 | 395 | 853 | 200 |
| PDD926 | 6 | 395 | 987 | 200 |

APARTMENT LETTER-BOX STANDS

Standard stands - designed for attachment of the letter-boxes from 1 to 4 grouped units. Every unit may contain from 2 to 10 collective delivery points. A stand may also be used for individual letter-boxes.

The stands are fabricated of black metal. Before painting process, stand's separate parts are coated by special black metal zinc-primer. Afterwards, a product is polyester powder paint coated.

Multiple letter-boxes' stands are also available in stainless steel.

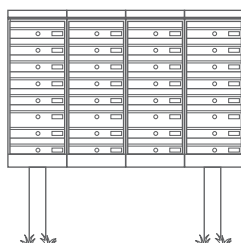
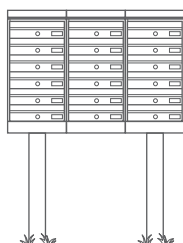
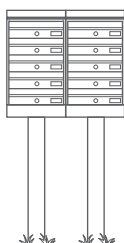
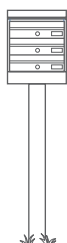

NUMBERING OF LETTER BOXES

The letter-boxes contain a number, title or surname tag slot.
Ordered letter-box can be numbered upon a request.

LASER NUMBERING

The digits are laser cut. The most durable way of numbering, resistant to fading away, peeling or wearing off.
The height of the digits is 25 mm.



PLOTTED STICKERS

The letter-boxes are numbered by plotted stickers.
The height of the digits is 25 mm.
Color range: white, black, golden.

DECORATIVE NUMBERING

You may choose from three different styles – „Pattern“, „Flora“ and „Frame“.

You may write down:

- A house number;
- Street name and a house number;
- Company name;





INDIVIDUAL LETTER BOXES

AESTHETIC AND DURABLE

Wide selection of post boxes will meet even the most exquisite taste. A post box will secure your correspondence and decorate a facade of your house, a fence, a staircase or an office.

The post boxes manufactured by us, ideally suits for both: outdoors and indoors. The post boxes are fabricated of zinc-galvanized sheet metal, then polyester powder paint coated.

FEATURES



Mail insert flap and roof makes a post box waterproof, thus protects your correspondence from a rain.



Secure locking mechanism. Two keys are added to each post box.

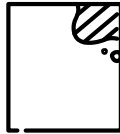

Zinc-galvanized, powder paint coated metal prevents a post box from corrosion.

STANDARD COLOR CODES



RAL 9010

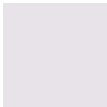

RAL 9016



SENAS VARIS



RAL 3005



RAL 6009



RAL 9005



RAL 9006



RAL 8017



RAL 3002



RAL 7016

A selection of different colours is available upon a request.



PD900

X: 290 Y: 385 Z: 100 (mm)



PD910

X: 410 Y: 310 Z: 135 (mm)



PD920

X: 410 Y: 310 Z: 100 (mm)



PD930

X: 250 Y: 380 Z: 50 (mm)



PD940

X: 260 Y: 400 Z: 100 (mm)



PD948

X: 380 Y: 332 Z: 170 (mm)



PD950

X: 250 Y: 380 Z: 70 (mm)



PD951

X: 250 Y: 380 Z: 75 (mm)



PD955

X: 240 Y: 355 Z: 55 (mm)



PD958

X: 256 Y: 415 Z: 80 (mm)



PD961

X: 370 Y: 320 Z: 90 (mm)



PD961V

X: 370 Y: 320 Z: 90 (mm)

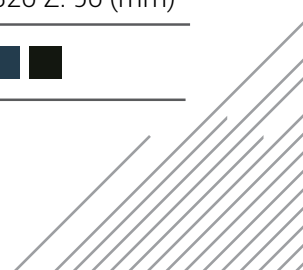



PD967



STAINLESS STEEL DOORS



STAINLESS STEEL

X: 375 Y: 306 Z: 90 (mm)



PD967T

X: 374 Y: 366 Z: 89 (mm)



Stainless steel doors



PD968

X: 359 Y: 252 Z: 89 (mm)



PD969

X: 420 Y: 354 Z: 100 (mm)



PD970

X: 400 Y: 400 Z: 120 (mm)



GA05

X: 422 Y: 341 Z: 175 (mm)

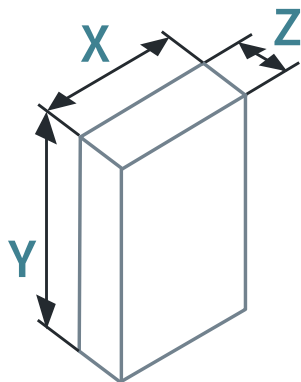

PARCEL BOX

Parcel box is designed for convenient and secure storage of small and medium parcels.



MOUNTABLE TWO-SIDED LETTER-BOX PD92M

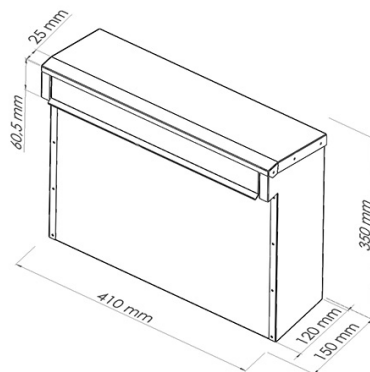

This double-faced letter-box is mountable either into the facade of a building or a fence. The correspondence is delivered from external side and collected from inside.

There is designated slot for a house number, a title or a surname on most of the letter boxes.





WEATHERVANES

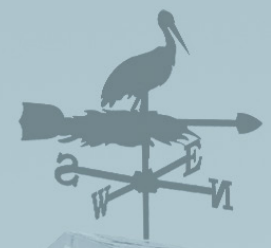

EXCEPTIONAL DECORATION OF A HOUSE

Adopting ancient Baltic and Germanic traditions we produce high quality and exclusive design weathervanes. We offer a wide range of weathervanes' motifs for the one to choose from, thus you may acquire the best match to your surrounding and buildings. The weathervanes are made of steel, then polyester powder paint coated.

FEATURES

45+
designs

Huge design selection for everyone's taste.

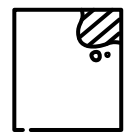

Powder paint coated metal prevents a weathervane from corrosion.

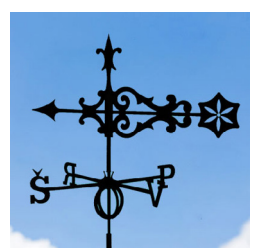
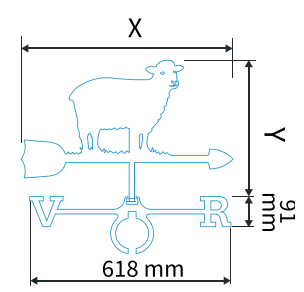

SUN

V-609 X: 760 mm Y: 460 mm



MOTIVE

V-603 X: 770 mm Y: 510 mm



MOTIVE 2

V-612 X: 790 mm Y: 480 mm



MOTIVE 3

V-618 X: 710 mm Y: 350 mm



ELK

V-606 X: 620 mm Y: 580 mm



WITCH

V-608 X: 630 mm Y: 530 mm



FISHERMAN

V-627 X: 630 mm Y: 530 mm



CAT

V-607 X: 590 mm Y: 580 mm

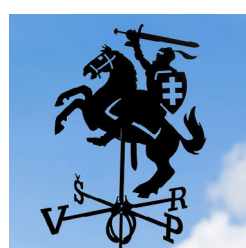

COAT OF ARMS THE REPUBLIC OF LITHUANIA

V-656 X: 530 mm Y: 600 mm



COCK

V-602 X: 560 mm Y: 580 mm



SHIP

V-611 X: 740 mm
Y: 510 mm



MUSTANG

V-605 X: 720 mm
Y: 400 mm



LION

V-625 X: 690 mm
Y: 480 mm



CHIMNEY-SWEEP

V-626 X: 710 mm
Y: 550 mm



KNIGHT

V-617 X: 640 mm
Y: 670 mm



FLYING STORK

V-642 X: 670 mm
Y: 565 mm

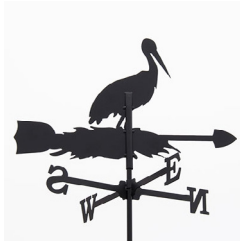

STORK

V-701 X: 642 mm
Y: 378 mm



DRAGON

V-702 X: 668 mm
Y: 375 mm

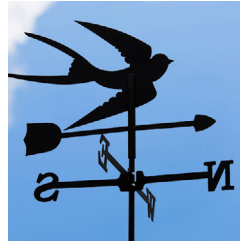

SWALLOW

V-703 X: 705 mm
Y: 460 mm



HUNTER

V-638 X: 660mm
Y: 430 mm



BEE

V-700 X: 720 mm
Y: 375 mm



FARMER

V-644 X: 660 mm
Y: 390 mm



SAINT-BERNARD

V-633 X: 650mm
Y: 520 mm



NIXIE

V-616 X: 960 mm
Y: 450 mm

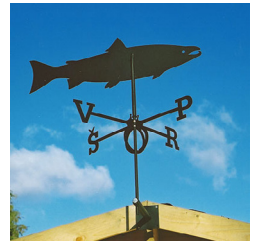

SALMON

V-614 X: 780 mm
Y: 380 mm



BEAR

V-615 X: 710 mm
Y: 380 mm



PEGASUS

V-622 X: 560 mm
Y: 630 mm



DOPLHIN

V-624 X: 760mm
Y: 450 mm



EAGLE

V-620 X: 660 mm
Y: 450 mm



WOLF-DOG

V-623 X: 620 mm
Y: 490 mm



PARROT

V-404 X: 465 mm
Y: 400 mm



WOOD-GROUSE

V-610 X: 560 mm
Y: 540 mm



SHARK

V-604 X: 790 mm
Y: 370 mm



DOG

V-601 X: 630 mm
Y: 530 mm



GULL

V-621 X: 600 mm
Y: 550 mm



SHEEP

V-645 X: 630 mm
Y: 410 mm



CENTAUR

V-613 X: 610 mm
Y: 585 mm



PIRATE

V-631 X: 690 mm
Y: 530 mm



TROLL

V-641 X: 645 mm
Y: 465 mm



VIKING

V-640 X: 590 mm
Y: 445 mm



CRANE

V-628 X: 670 mm
Y: 560 mm



RIDER

V-639 X: 635mm
Y: 370 mm



FOOTBALLIST

V-625 X: 690 mm
Y: 480 mm



SKIER

V-630 X: 600 mm
Y: 410 mm



NORTH DEER

V-634 X: 595 mm
Y: 610 mm



BIKER

V-637 X: 580 mm
Y: 400 mm



OX

V-643 X: 670mm
Y: 380 mm



SWAN

V-647 X: 695 mm
Y: 495 mm

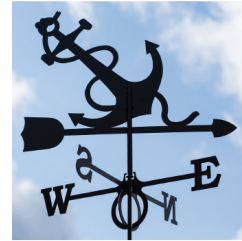

ANCHOR

V-646 X: 645 mm
Y: 560 mm



COW

V-636 X: 645mm
Y: 425 mm

WEATHERVANES' ROOFHOLDERS



**HORIZONTAL
ROOFHOLDER**

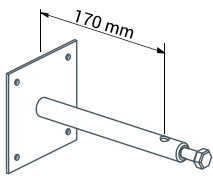

**VERTICAL
ROOFHOLDER**

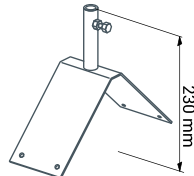

**VERTICAL
ADJUSTABLE
ROOFHOLDER**

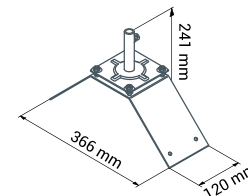

WEATHERVANES WITH BEARINGS



A bearing increases sensitivity to the wind.

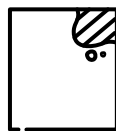

Powder paint coated metal prevents a weathervane from corrosion.

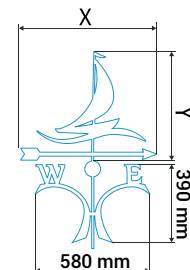

COCK

V-651 X: 630 mm
Y: 395 mm

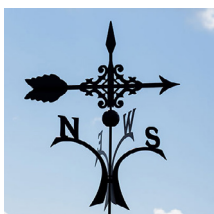

MOTIVE

V-652 X: 710 mm
Y: 430 mm



CAT

V-653 X: 630 mm
Y: 400 mm

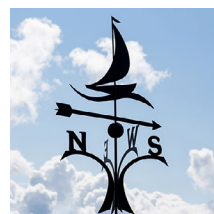

SHIP

V-654 X: 652 mm
Y: 562 mm



WITCH

V-655 X: 705 mm
Y: 488 mm



CLASSICAL "VYTIS"

V-657 X: 658 mm
Y: 490 mm



DECORATE YOUR HOME

Flower pot brackets are designed for hanging flowers. Metal fabric is polyester paint coated in black colour. Metal flower pot bracket is wall mountable.

FEATURES

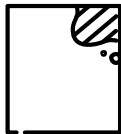

Powder paint coated metal is prevented from corrosion.

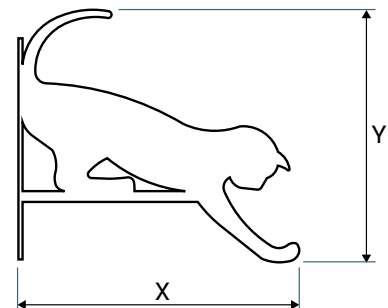

BIRDS
(GL-213)

X: 370 mm Y: 200 mm



ELK
(GL-212)

X: 390 mm Y: 300 mm



WITCH
(GL-211)

X: 390 mm Y: 300 mm



DOG
(GL-209)

X: 390 mm Y: 280 mm



DEERS
(GL-203)

X: 390 mm Y: 300 mm



WOODPECKER
(GL-206)

X: 370 mm Y: 200 mm



HORSE
(GL-204)

X: 390 mm Y: 290 mm



PARROT
(GL-201)

X: 315 mm Y: 210 mm



CAT
(GL-205)

X: 370 mm Y: 340 mm



MOTIVE
(GL-202)

X: 375 mm Y: 200 mm



MOTIVE 2
(GL-207)

X: 395 mm Y: 200 mm



MOTIVE 3
(GL-208)

X: 380 mm Y: 200 mm



ACCESS PANELS

MATCHING YOUR NEEDS

Designation of access panels is to cover plumbing units, electrical units and other types of home installation. They are easily fitting to the walls and ceilings, are durable and reliable. Access panels are made of black or zinc-galvanized metal, also stainless steel. Moreover, we accept individual access panel orders based on special requirements of a customer.

'PUSH-TO-OPEN' SYSTEM



DIMENSIONS (mm)

| CODE | X OUT | Y OUT | X IN | Y IN | Z |
|----------------|-------|-------|------|------|----|
| RD-FZN-150x150 | 184 | 184 | 146 | 146 | 24 |
| RD-FZN-200x200 | 234 | 234 | 196 | 196 | 24 |
| RD-FZN-300x300 | 334 | 334 | 296 | 296 | 24 |
| RD-FZN-300x800 | 334 | 834 | 296 | 796 | 24 |
| RD-FZN-400x400 | 434 | 434 | 396 | 396 | 24 |
| RD-FZN-400x800 | 434 | 834 | 396 | 796 | 24 |
| RD-FZN-500x500 | 534 | 534 | 496 | 496 | 24 |
| RD-FZN-500x800 | 534 | 834 | 496 | 796 | 24 |
| RD-FZN-600x600 | 634 | 634 | 596 | 596 | 24 |
| RD-FZN-600x800 | 634 | 834 | 596 | 796 | 24 |

'PUSH-TO-OPEN' SYSTEM

Only a gentle press opens a door. No need for keys or any tools!

ZINC-GALVANIZED METAL

Powder paint coated surface is corrosion resistant.

EASILY REMOVABLE

Simply mountable / unmountable access panel doors.

MATT-WHITE COLOUR

Ideal choice for the painted ceilings and walls.

AESTHETIC AND MINIMALISTIC

Matching to various interior styles.

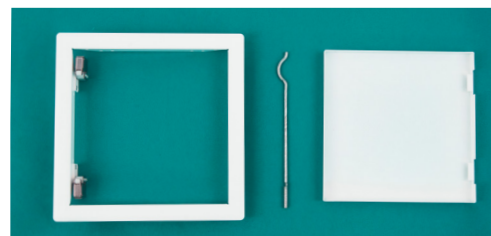

WITH A LOCK



GUARD AGAINST STRANGERS

Protect electrical and / or plumbing units from unauthorized persons or children by installing locking access panels.

TWO KEYS SET

Two keys set is added to each access panel door.

WITHOUT LOCK



SIMPLE OPENING

Simply open the door using a screwdriver or an ordinary key.

Made of black metal and polyester powder paint coated.

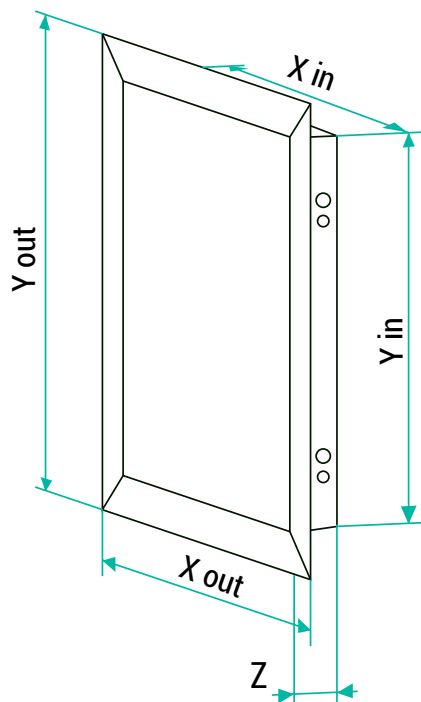

DIMENSIONS (mm)

| CODE | X OUT | Y OUT | X IN | Y IN | Z |
|------------|-------|-------|------|------|----|
| RD 150x150 | 184 | 184 | 146 | 146 | 24 |
| RD-150x200 | 184 | 234 | 146 | 196 | 24 |
| RD-150x250 | 184 | 284 | 146 | 246 | 24 |
| RD-150x300 | 184 | 334 | 146 | 296 | 24 |
| RD-200x200 | 234 | 234 | 196 | 196 | 24 |
| RD-200x250 | 234 | 284 | 196 | 246 | 24 |
| RD-200x300 | 234 | 334 | 196 | 296 | 24 |
| RD-200x400 | 234 | 434 | 196 | 396 | 24 |
| RD-250x250 | 284 | 284 | 246 | 246 | 24 |
| RD-250x300 | 284 | 334 | 246 | 296 | 24 |
| RD-250x350 | 284 | 384 | 246 | 346 | 24 |
| RD-250x400 | 284 | 434 | 246 | 396 | 24 |
| RD-300x300 | 334 | 334 | 296 | 296 | 24 |
| RD-300x400 | 334 | 434 | 296 | 396 | 24 |
| RD-300x500 | 334 | 534 | 296 | 496 | 24 |
| RD-300x600 | 334 | 634 | 296 | 596 | 24 |
| RD-350x350 | 384 | 384 | 346 | 346 | 24 |
| RD-350x450 | 384 | 484 | 346 | 446 | 24 |
| RD-400x400 | 434 | 434 | 396 | 396 | 24 |
| RD-400x500 | 434 | 534 | 396 | 496 | 24 |
| RD-400x600 | 434 | 634 | 396 | 596 | 24 |
| RD-500x500 | 534 | 534 | 496 | 496 | 24 |
| RD-500x600 | 634 | 534 | 596 | 496 | 24 |
| RD-600x600 | 634 | 634 | 596 | 596 | 24 |

STAINLESS STEEL

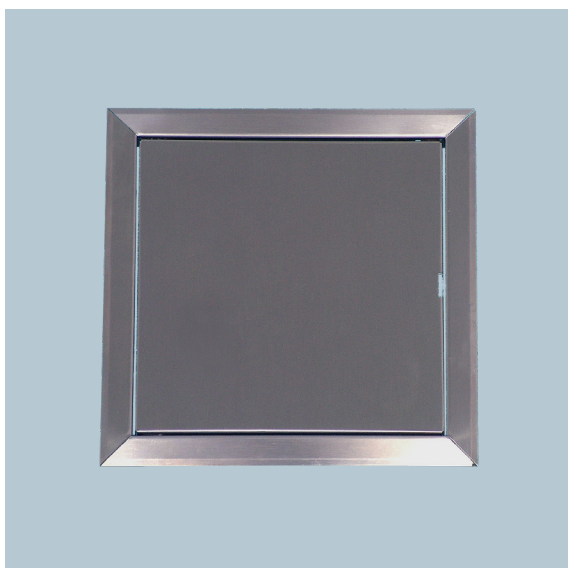

DIMENSIONS (mm)

| CODE | X OUT | Y OUT | X IN | Y IN | Z |
|---------------|-------|-------|------|------|----|
| RD-NP-150x150 | 184 | 184 | 146 | 146 | 24 |
| RD-NP-200x200 | 234 | 234 | 196 | 196 | 24 |
| RD-NP-200x300 | 234 | 334 | 196 | 296 | 24 |
| RD-NP-300x300 | 334 | 334 | 296 | 296 | 24 |
| RD-NP-300x400 | 334 | 434 | 296 | 396 | 24 |
| RD-NP-400x400 | 434 | 434 | 396 | 396 | 24 |

WIDE RANGE

- Available:
- with a lock;
 - without a lock;
 - with a 'push to open' mechanism.

STAINLESS STEEL

Suitable for using in an aggressive environment.

FIRE RATED ACCESS PANELS

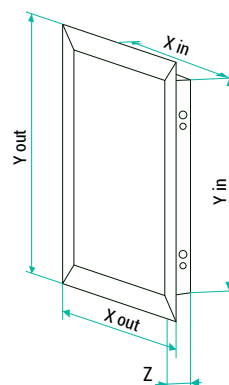

DIMENSIONS (mm)

| CODE | X OUT | Y OUT | X IN | Y IN | Z |
|-------------|-------|-------|------|------|----|
| PRD-150x150 | 185 | 185 | 150 | 150 | 48 |
| PRD-200x200 | 235 | 235 | 200 | 200 | 48 |
| PRD-200x300 | 235 | 335 | 200 | 300 | 48 |
| PRD-300x200 | 335 | 235 | 300 | 200 | 48 |
| PRD-300x300 | 335 | 335 | 300 | 300 | 48 |
| PRD-300x400 | 335 | 435 | 300 | 400 | 48 |
| PRD-400x300 | 435 | 335 | 400 | 300 | 48 |
| PRD-400x400 | 435 | 435 | 400 | 400 | 48 |
| PRD-400x600 | 435 | 635 | 400 | 600 | 48 |
| PRD-500x500 | 535 | 535 | 500 | 500 | 48 |
| PRD-500x600 | 535 | 635 | 500 | 600 | 48 |
| PRD-600x400 | 635 | 435 | 600 | 400 | 48 |
| PRD-600x500 | 635 | 535 | 600 | 500 | 48 |
| PRD-600x600 | 635 | 635 | 600 | 600 | 48 |

Fire-rated hatches are ceiling or wall mountable. They are used for accessing electrical and / or plumbing units and other types of installation.

Two resistance classes are produced: EI2 30 and EI2 60 in compliance with EN 13501-2, i.e. in case of fire its solidity and heat insulation lasts from 30 to 60 min. respectively. DOP (Declaration of Performance) documents are available.

Fire-rated hatches are fabricated of 1 mm zinc-galvanized sheet steel, then polymeric paint coated in RAL9010. EI2, 30 - 40 mm thick mineral wool plate, EI2 30 - 60 mm thick mineral wool plate and 9 mm thick magnesium silicate plate are used for insulation.

The hatches have a universal locking mechanism installed. Wide range in size is available.

NON-STANDARD DIMENSIONS FOR CUSTOMIZED ORDERS

Non-standard, bigger dimensions access panels have wider and more robust frame.

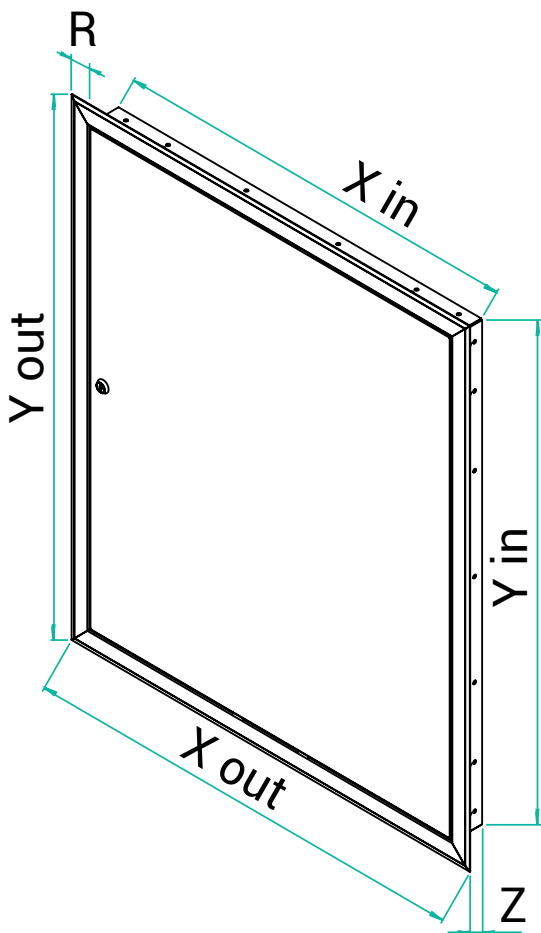

REMOVABLE DOOR



DIFFERENT LOCKING MECHANISM OPTIONS AVAILABLE

Z=60 mm
R=35 mm

EXTERNAL ACCESS PANELS

QUICK MOUNTING

Only a frame needs to be screwed to the wall and the door inserted into it.

EASY COVERING OF WALL GAPS

There is no need to break the wall and unmount old communication or other type of boxes.

- Made of zinc-galvanized sheet metal
- Covered by polyester powder coat
- Removable doors
- Different locking options
- Standard dimensions are listed in a table below
- Manufacturing of customized dimension access panels is also in practice

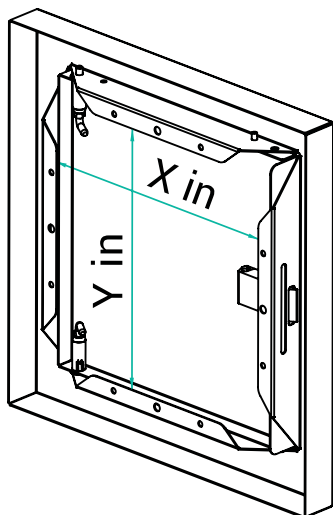
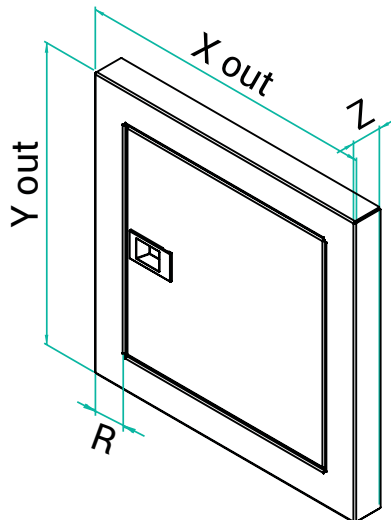

DIMENSIONS (mm)

| CODE | X OUT | Y OUT | X IN | Y IN | Z |
|-------------|-------|-------|------|------|----|
| RDV-200x200 | 302 | 302 | 205 | 205 | 30 |
| RDV-300x300 | 402 | 402 | 305 | 305 | 30 |
| RDV-300x400 | 402 | 502 | 305 | 405 | 30 |
| RDV-400x400 | 502 | 502 | 405 | 405 | 30 |
| RDV-400x600 | 502 | 702 | 405 | 605 | 30 |
| RDV-500x500 | 602 | 602 | 505 | 505 | 30 |
| RDV-500x800 | 602 | 902 | 505 | 805 | 30 |
| RDV-600x600 | 702 | 702 | 605 | 605 | 30 |

Z=60 mm
R=35 mm



• SCREW THE FRAME TO THE WALL • INSERT THE DOOR • DONE!



OTHER ACCESS PANELS

Durable solution for main electrical service panels in multi-flat houses.



Easily and quickly
assemblable.



Zinc-galvanized, powder paint
coated metal is robust and
corrosion resistant.



WITH METER
READING SLOTS



WITHOUT METER
READING SLOTS



MANIFOLD CABINET

‘USER FRIENDLY’ ACCESS

Manifold cabinets are easy to assemble and install. Zinc-galvanized metal and polyester powder paint coated surface makes the product reliably resistant to negative environmental influence.

EXTERNAL MANIFOLD CABINET

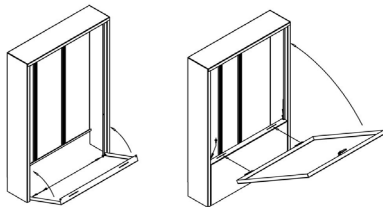

'User friendly' access - simply mountable / unmountable door.

DIMENSIONS (MM)

| MODEL | X | Y | Z |
|--------|-----|-----|-----|
| KSV-35 | 370 | 680 | 115 |
| KSV-44 | 465 | 680 | 115 |
| KSV-57 | 595 | 680 | 115 |
| KSV-70 | 725 | 680 | 115 |
| KSV-77 | 795 | 680 | 115 |
| KSV-95 | 975 | 680 | 115 |

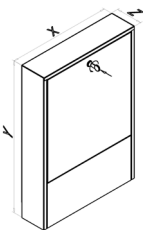

INTERNAL MANIFOLD CABINET

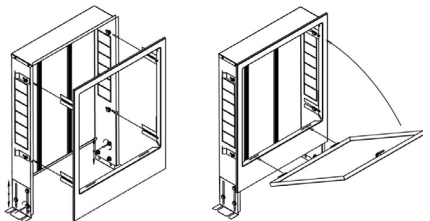

'User friendly' access - simply mountable / unmountable door.

DIMENSIONS (MM)

| MODEL | X | Y | Z |
|--------|-----|---------|---------|
| KSP-35 | 350 | 700/800 | 115/165 |
| KSP-44 | 440 | 700/800 | 115/165 |
| KSP-57 | 570 | 700/800 | 115/165 |
| KSP-70 | 700 | 700/800 | 115/165 |
| KSP-77 | 770 | 700/800 | 115/165 |
| KSP-95 | 950 | 700/800 | 115/165 |

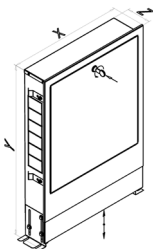



FLAT VENTILATION DUCTS

QUICK INSTALLATION

Flat ventilation duct piping is suitable for cold and warm air flow. Such type of ventilation ducts are irreplaceable in buildings with walls too thin for any other option. The ventilation ducts perfectly fits in saunas, they may be installed under a floor, mounted into a drywall or directing hot air flow coming out of a fireplace.

FEATURES



Ideally suits for either cold or hot air flow.

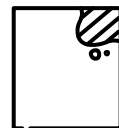

Zinc-galvanized metal is corrosion resistant.

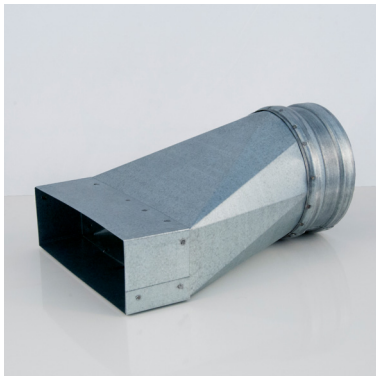

150X50MM Standard dimension

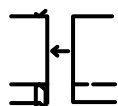
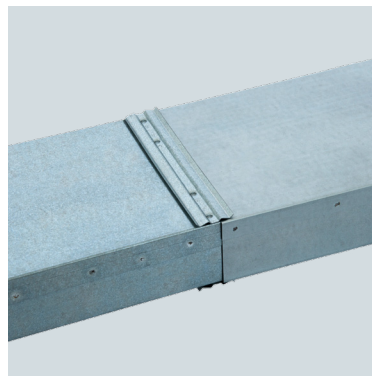

Quick and 'user-friendly' joining.

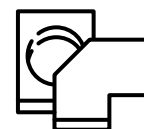
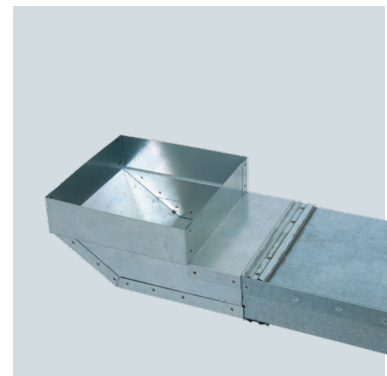

Wide range of products

FLAT VENTILATION DUCTS MODELS

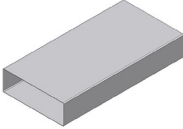
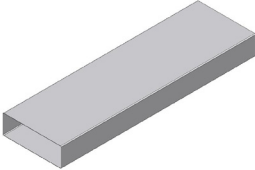
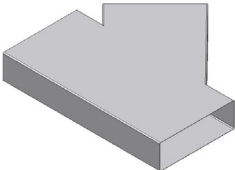
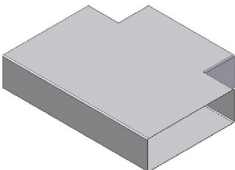
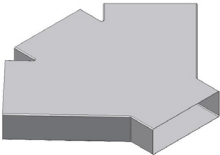
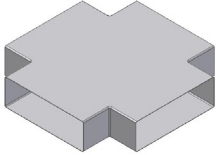
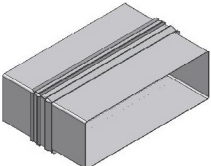
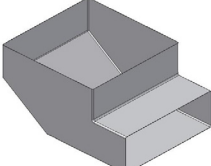
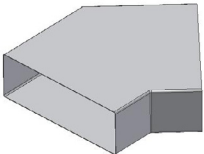
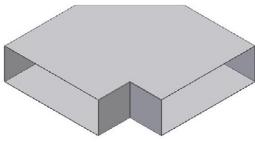
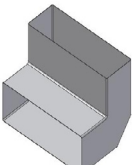
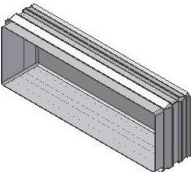
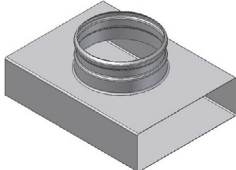
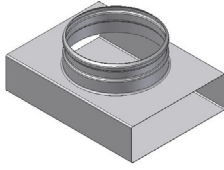
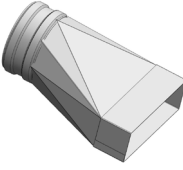
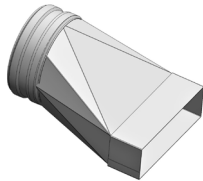
| | | | |
|---|---|--|---|
|  |  |  |  |
| DUCT 5V15-50 | DUCT 5V15-100 | TEE JOINT 5T15/1*45 | TEE JOINT 5T15/1*90 |
|  |  |  |  |
| FOUR-BRANCH 5K15/2*45 | FOUR-BRANCH 5K15/2*90 | CONNECTOR 5J15 | OUTLET 5G15-15x15 |
|  |  |  |  |
| SHAPED 5F15/45 | SHAPED 5F15/90 | ELBOW 5A15/90 | PLUG 5G15 |
|  |  |  |  |
| ADAPTER 5TP15D10 | ADAPTER 5TP15D12 | ASYMMETRIC ADAPTER 5TN15D10 | ASYMMETRIC ADAPTER 5TN15D12 |

VENTILATION GRATES

| DIMENSIONS (mm) | | | |
|-----------------|-----|-----|----|
| CODE | X | Y | Z |
| VG-100x250 | 134 | 284 | 24 |
| VG-100x300 | 134 | 334 | 24 |
| VG-100x400 | 134 | 434 | 24 |
| VG-100x500 | 134 | 534 | 24 |
| VG-150x150 | 184 | 184 | 24 |
| VG-150x300 | 184 | 384 | 24 |
| VG-150x400 | 134 | 434 | 24 |
| VG-150x500 | 184 | 534 | 24 |
| VG-200x500 | 234 | 534 | 24 |





FIREWOOD TROLLEY ON WHEELS

LUXURIOUS DESIGN

'User-friendly', modern and fine quality firewood storage trolley on the wheels designed for your home! Stylish and functional metal trolley for firewood on the wheels may decorate both: an interior and a terrace. The trolley can be simply used as a wood storage cart next to a fireplace or for shifting the wood logs around, to the fireplace, stove, grill or other source of fire.

FEATURES



Rubber wheels for easier carrying of the wood logs.

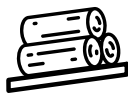

Log shelf tilted design ensures secure storage.



Extra mini shelf for kindling wood, matches, gloves, etc;



Rubber wheels and legs protect your floor surface.



Modern design.



Ergonomic and comfortable grip handle made of oak.

RUBBER WHEELS

OAK HANDLE

RUBBER LEGS



DEINA

DEINA MIDI

X: 340 MM
Y: 960 MM
Z: 380 MM



15 KG



85 L



X: 340 MM
Y: 720 MM
Z: 380 MM



10 KG



55 L



FINE TEXTURE BLACK

ANTIQUE WHITE GOLD

BROWN RUST



MINIMAL PINE TREE

DECORATIVE FLOWER

YOUR CUSTOM DESIGN





PELLET STORAGE BIN

SIMPLE ASSEMBLY

Robust and capacious pellet storage box. Since a pellet container is fabricated of zinc-galvanized sheet metal, it is distinctive by a high resistance to a negative environmental influence and durability. Pellet storage box dimensions are customized upon a request.

FEATURES



Options of 350 or 450 litres available.

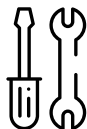

A product is easily assemblable.

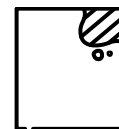

Zinc-galvanized metal is corrosion resistant.

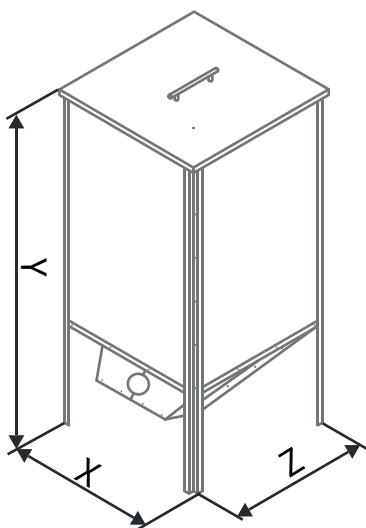

DIMENSIONS (MM)

| CAPACITY | X | Y | Z |
|----------|-----|------|-----|
| 350 L | 640 | 1383 | 640 |
| 450 L | 740 | 1383 | 740 |





OTHER PRODUCTS

QUALITY PRODUCTS

KEY BOX

(R-01)

A box contains 36 key hooks inside.

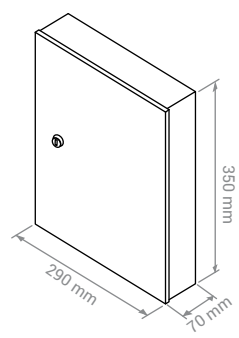

MEDICINE BOX

(V-01)

3 sections for medicaments.

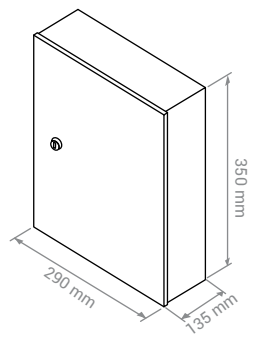

BOX FOR ELECTRONICS

(ASD2)

A box is suitable for the alarm systems.

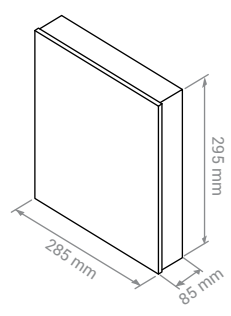

SKEWER GRILL BOX (BBQ GRILL BOX)

Assemblable skewer grill box for outdoor leisure time.

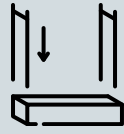

Ordinary assembly / disassembly.



Space saving (disassembled), thus convenient to store or transport.

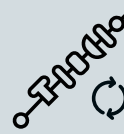

Designed for skewer grilling on all sides of the grill box.

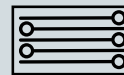

Designed for safe skewer transportation.

DIMENSIONS (MM)

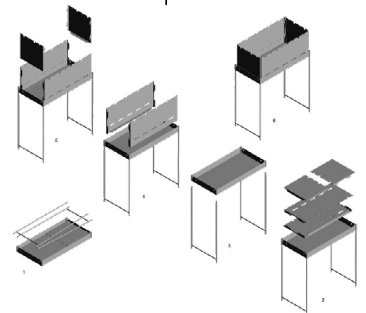
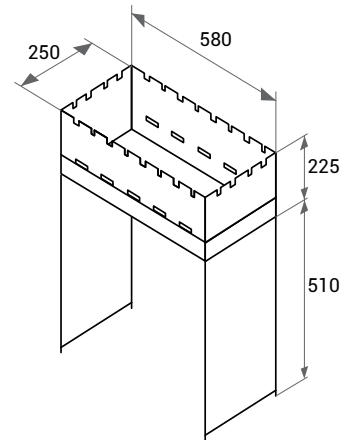

INFORMATION DISPLAY STAND

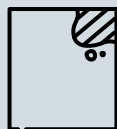

Made of sheet metal and powder paint coated, thus robust and durable.



Fitting four A4 size sheets.

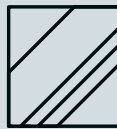

A product has an organic glass.



16 magnets for information sheet attachment are added to each product.



Secure locking mechanism. Two keys are added to each information stand.

DIMENSIONS (MM)

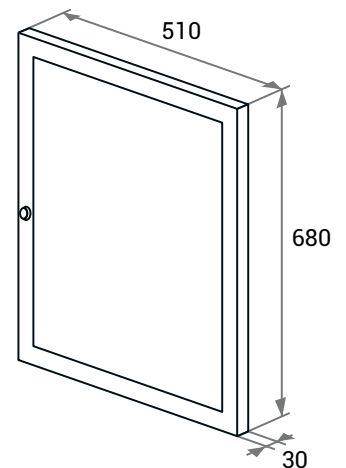

FIREPITS

For the bright cozy and warm evening relaxation outdoors.

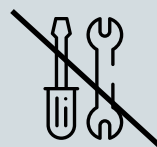

Easy to assemble and disassemble.



“SPARK”

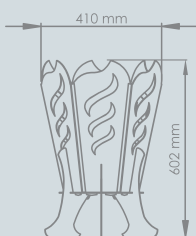

“BALTIC FIR”

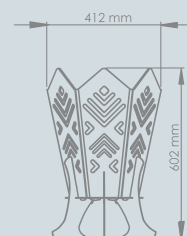

“BALTIC HOME”

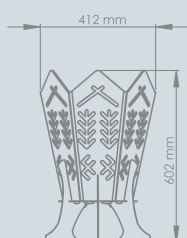

„SUNRISE“

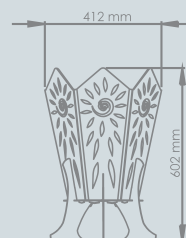

PRODUCTION DISPLAY STANDS

Stands are used for production exhibition in the shopping malls.



A STAND FOR THE LETTER-BOXES.



A STAND FOR THE WEATHERVANES.

FOR NOTES

A large grid of small black dots for taking notes, consisting of 20 columns and 30 rows.

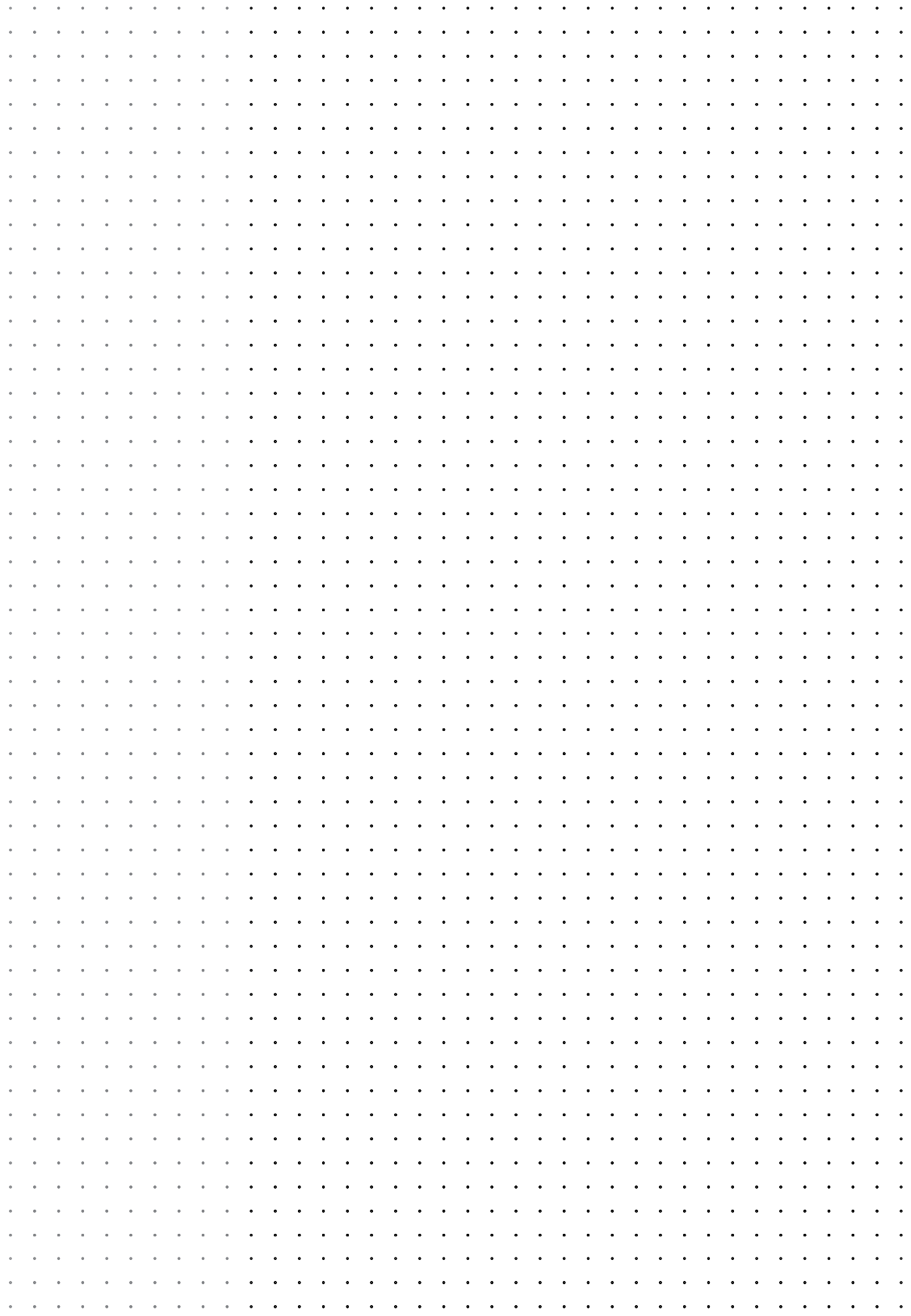

CONTACTS:



Glori ir Ko



+370 37 536110

+370 37 536166



INFO@GLORI.LT



OFFICE / FACTORY

+370 37 536110
info@glori.lt



MANAGER OF SUPPLY AND
WESTERN REGIONS OF LITHUANIA

+370 37 536110
+370 614 23213
tiekimas@glori.lt



MANAGER OF EASTERN REGIONS
OF LITHUANIA

+370 37 536110
+370 698 12604
pardavimai@glori.lt



EXPORT MANAGER

+370 37 536110
+370 698 00956
export@glori.lt



GLORI.LT



FB.COM/GLORIIRKO



LINKEDIN.COM/COMPANY/GLORI-IR-KO

You can find us here:

**KAUNO G. 19
ILGAKIEMIO K., KAUNO R.,
LT-53288, LITHUANIA**

