

CHIAVI CILINDRO

CYLINDER KEYS

ZYLINDERSCHLÜSSEL

CLÉS POUR SERRURES À CYLINDRE

LLAVES PARA CERRADURAS A CILINDRO



TO FIT : **ABLOY (S)**



AB1P



VERSA

OPTIONAL

code

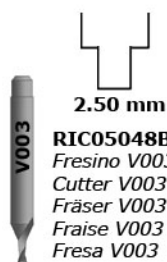

RIC05048B
Fresino V003
Cutter V003
Fräser V003
Fraise V003
Fresa V003

OPZ08254B
Morsetto C17 Versa
Jaw C17 Versa
Spannbacken C17 Versa
Étaux C17 Versa
Mordaza C17 Versa

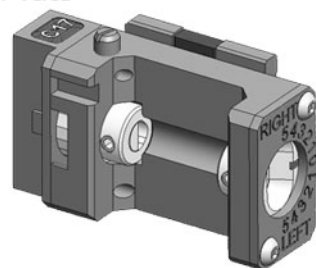

TO FIT : **ABUS (D)**

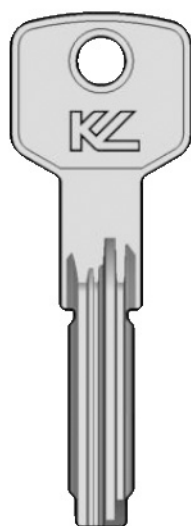

ABU48



VERSA

STANDARD

code

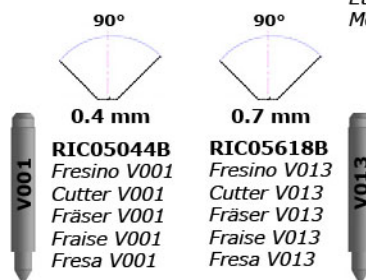

RIC05044B
Fresino V001
Cutter V001
Fräser V001
Fraise V001
Fresa V001

RIC05618B
Fresino V013
Cutter V013
Fräser V013
Fraise V013
Fresa V013

OPZ04879B
Morsetto C01 Versa
Jaw C01 Versa
Spannbacken C01 Versa
Étaux C01 Versa
Mordaza C01 Versa

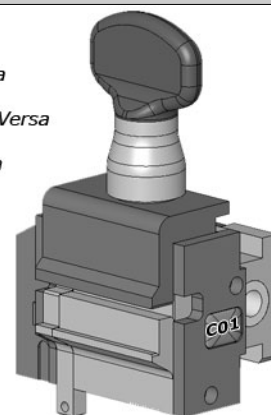

STANDARD



OPZ04879B
 Morsetto C01 Versa
 Jaw C01 Versa
 Spannbacken C01 Versa
 Étaux C01 Versa
 Mordaza C01 Versa

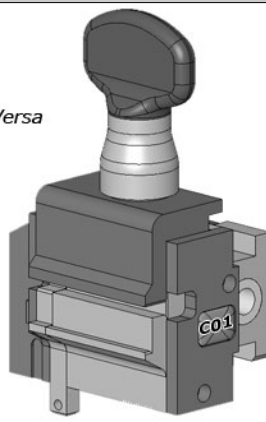

VERSA

Extra Classe



→ CISA

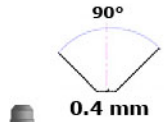

V001
RIC05044B
 Fresino V001
 Cutter V001
 Fräser V001
 Fraise V001
 Fresa V001

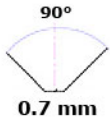

V013
RIC05618B
 Fresino V013
 Cutter V013
 Fräser V013
 Fraise V013
 Fresa V013

STANDARD



OPZ04879B
 Morsetto C01 Versa
 Jaw C01 Versa
 Spannbacken C01 Versa
 Étaux C01 Versa
 Mordaza C01 Versa

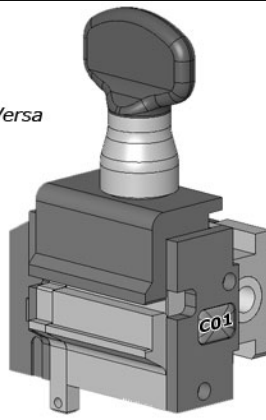

VERSA

XP2

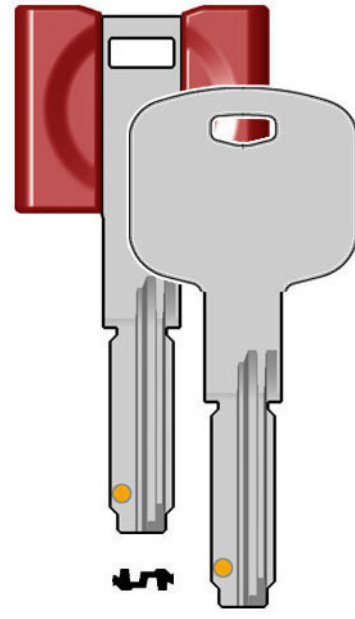

→ CISA



DX6-DX8

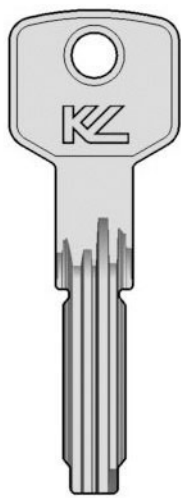

→ CISA



VERSA

STANDARD

code

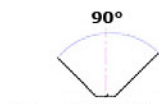

0.4 mm



RIC05044B
Fresino V001
Cutter V001
Fräser V001
Fraise V001
Fresa V001

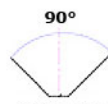

0.7 mm



RIC05618B
Fresino V013
Cutter V013
Fräser V013
Fraise V013
Fresa V013

OPZ04879B

Morsetto C01 Versa
Jaw C01 Versa
Spannbacken C01 Versa
Étaux C01 Versa
Mordaza C01 Versa

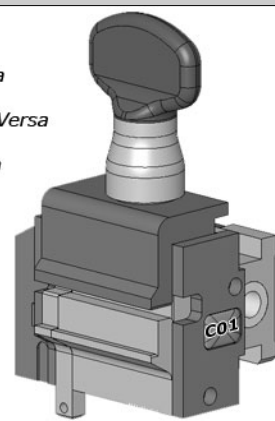

VERSA

STANDARD

code

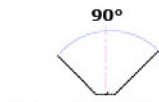

0.4 mm



RIC05044B
Fresino V001
Cutter V001
Fräser V001
Fraise V001
Fresa V001

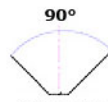

0.6 mm



RIC05612B
Fresino V014
Cutter V014
Fräser V014
Fraise V014
Fresa V014

OPZ04879B

Morsetto C01 Versa
Jaw C01 Versa
Spannbacken C01 Versa
Étaux C01 Versa
Mordaza C01 Versa

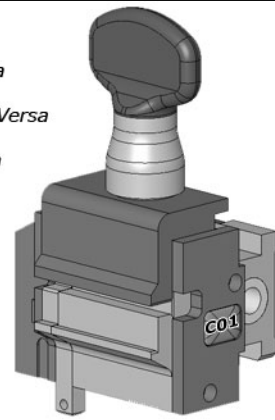

ORIGINAL

STANDARD

code

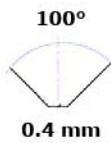

OPZ04879B
Morsetto C01 Versa
Jaw C01 Versa
Spannbacken C01 Versa
Étaux C01 Versa
Mordaza C01 Versa

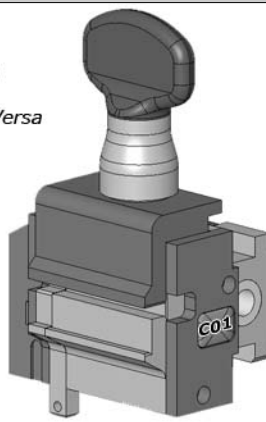

VERSA



RIC05264B
Fresino V007
Cutter V007
Fräser V007
Fraise V007
Fresa V007

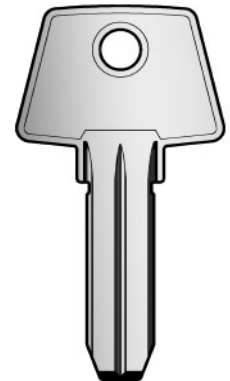

STANDARD

code

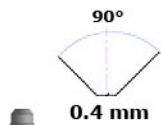

OPZ04879B
Morsetto C01 Versa
Jaw C01 Versa
Spannbacken C01 Versa
Étaux C01 Versa
Mordaza C01 Versa

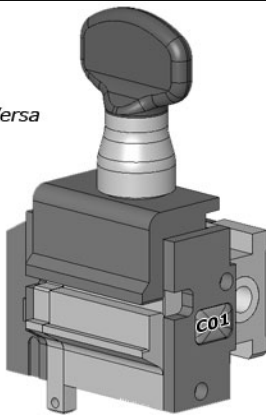

VERSA



RIC05044B
Fresino V001
Cutter V001
Fräser V001
Fraise V001
Fresa V001

RIC05618B
Fresino V013
Cutter V013
Fräser V013
Fraise V013
Fresa V013



SCUDO 9000

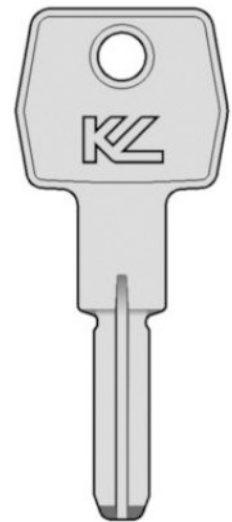

AGB1

Scudo 5000

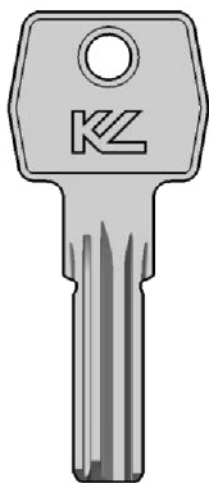

KZ
AGBG



VERSA

STANDARD

code



0.4 mm



RIC05044B
Fresino V001
Cutter V001
Fräser V001
Fraise V001
Fresa V001



0.6 mm



RIC05612B
Fresino V014
Cutter V014
Fräser V014
Fraise V014
Fresa V014

OPZ04879B
Morsetto C01 Versa
Jaw C01 Versa
Spannbacken C01 Versa
Étaux C01 Versa
Mordaza C01 Versa

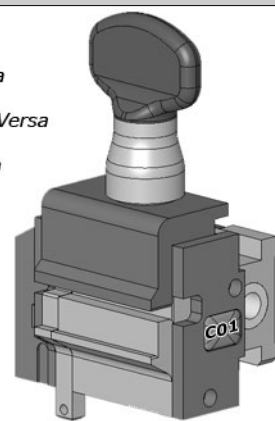

VERSA

STANDARD

code



0.4 mm



RIC05044B
Fresino V001
Cutter V001
Fräser V001
Fraise V001
Fresa V001



0.6 mm



RIC05612B
Fresino V014
Cutter V014
Fräser V014
Fraise V014
Fresa V014

OPZ04879B
Morsetto C01 Versa
Jaw C01 Versa
Spannbacken C01 Versa
Étaux C01 Versa
Mordaza C01 Versa

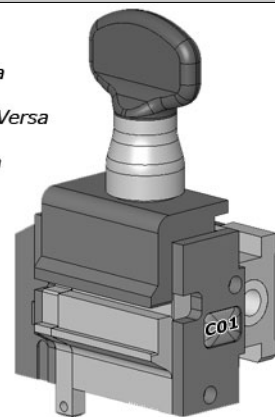

ORIGINAL

STANDARD



OPZ04879B
 Morsetto C01 Versa
 Jaw C01 Versa
 Spannbacken C01 Versa
 Étaux C01 Versa
 Mordaza C01 Versa

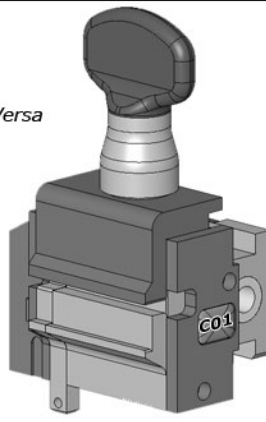

VERSA



0.4 mm

RIC05044B
 Fresino V001
 Cutter V001
 Fräser V001
 Fraise V001
 Fresa V001



0.7 mm

RIC05618B
 Fresino V013
 Cutter V013
 Fräser V013
 Fraise V013
 Fresa V013

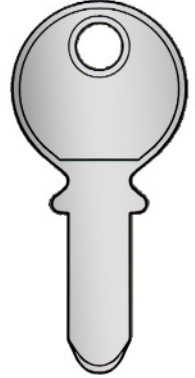

OPTIONAL



OPZ08254B
 Morsetto C18 Versa
 Jaw C18 Versa
 Spannbacken C18 Versa
 Étaux C18 Versa
 Mordaza C18 Versa

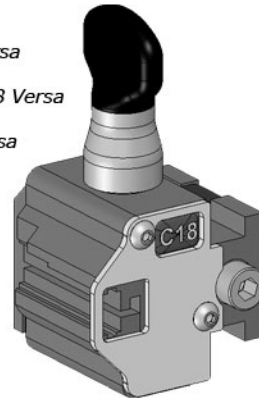

VERSA



1.50 mm

RIC05274B
 Fresino V012
 Cutter V012
 Fräser V012
 Fraise V012
 Fresa V012

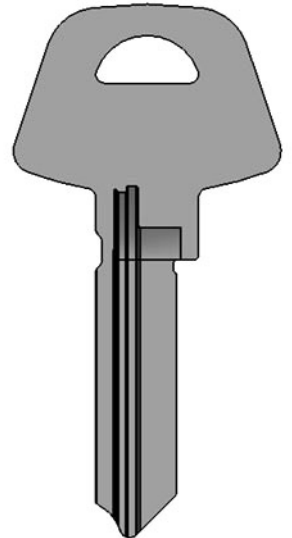

d-12

Serie 500
Serie 700

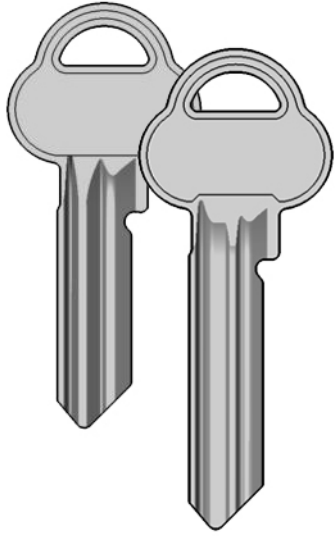

VERSA

OPTIONAL

CODE

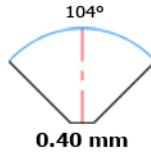

RIC06370B
Fresino V025
Cutter V025
Fräser V025
Fraise V025
Fresa V025

OPZ06039B

Morsetto C08 Versa
Jaw C08 Versa
Spannbacken C08 Versa
Étaux C08 Versa
Mordaza C08 Versa



Flexcore
Guideline
Twin
Serie 600



VERSA

OPTIONAL

CODE

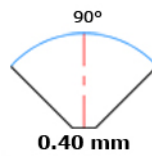

RIC05044B
Fresino V001
Cutter V001
Fräser V001
Fraise V001
Fresa V001
STANDARD

OR

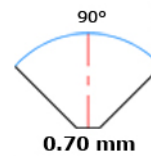

RIC05618B
Fresino V013
Cutter V013
Fräser V013
Fraise V013
Fresa V013
OPTIONAL

OPZ06039B

Morsetto C08 Versa
Jaw C08 Versa
Spannbacken C08 Versa
Étaux C08 Versa
Mordaza C08 Versa

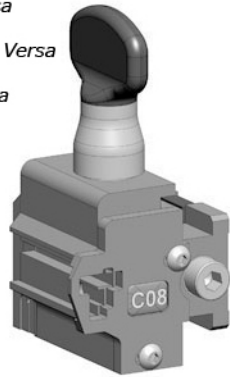

STANDARD

code

OPZ04879B
 Morsetto C01 Versa
 Jaw C01 Versa
 Spannbacken C01 Versa
 Étaux C01 Versa
 Mordaza C01 Versa

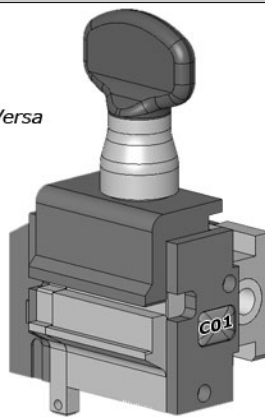

VERSA

Guideline

ORIGINAL

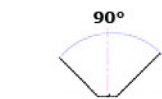

0.4 mm

**RIC05044B**

Fresino V001
 Cutter V001
 Fräser V001
 Fraise V001
 Fresa V001

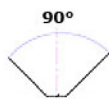

0.7 mm

**RIC05618B**

Fresino V013
 Cutter V013
 Fräser V013
 Fraise V013
 Fresa V013

OPTIONAL

CODE

OPZ06039B
 Morsetto C08 Versa
 Jaw C08 Versa
 Spannbacken C08 Versa
 Étaux C08 Versa
 Mordaza C08 Versa

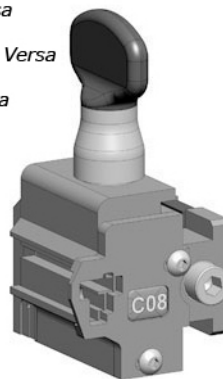

VERSA

ASSA DP

ORIGINAL

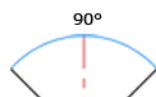

0.40 mm

**RIC05044B**

Fresino V001
 Cutter V001
 Fräser V001
 Fraise V001
 Fresa V001

OR

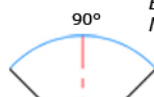

0.70 mm

**RIC05618B**

Fresino V013
 Cutter V013
 Fräser V013
 Fraise V013
 Fresa V013

OPTIONAL



1.5 mm

**RIC05274B**

Fresino V012
 Cutter V012
 Fräser V012
 Fraise V012
 Fresa V012

OPTIONAL

TO FIT : **ATRA (I)**

NEOS
BOSS



ISE14 ISE17P
ISE15 ISE15P
ISE17 ISE14P



VERSA

STANDARD

code

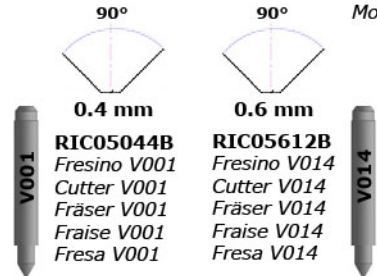

RIC05044B
Fresino V001
Cutter V001
Fräser V001
Fraise V001
Fresa V001

RIC05612B
Fresino V014
Cutter V014
Fräser V014
Fraise V014
Fresa V014

OPZ04879B
Morsetto C01 Versa
Jaw C01 Versa
Spannbacken C01 Versa
Étaux C01 Versa
Mordaza C01 Versa

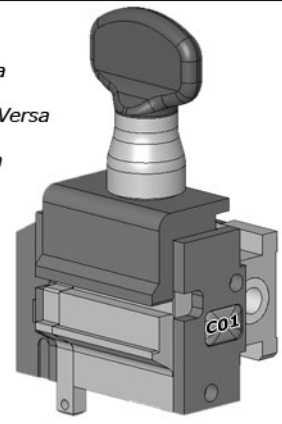

TO FIT : **AXA (NL)**

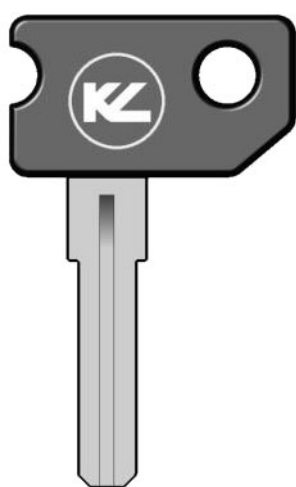

AXA1P



VERSA

OPTIONAL

CODE



RIC05506B
Fresino V016
Cutter V016
Fräser V016
Fraise V016
Fresa V016



OPZ06511B
Adattatore AV06 per chiavi Axa
Adaptor AV06 for Axa keys
Spannbacken AV06 für Axa-Schlüssel
Étaux AV06 pou clés Axa
Mordaza AV06 para llaves Axa

OPZ04875B
Morsetto A03 Versa
Jaw A03 Versa
Spannbacke A03 Versa
Étau A03 Versa
Mordaza A03 Versa

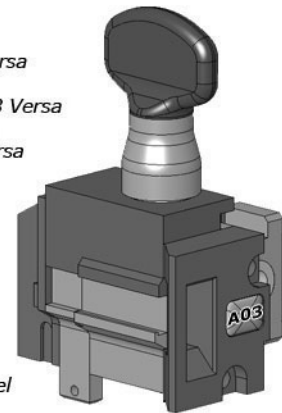

STANDARD



OPZ04879B
 Morsetto C01 Versa
 Jaw C01 Versa
 Spannbacken C01 Versa
 Étaux C01 Versa
 Mordaza C01 Versa

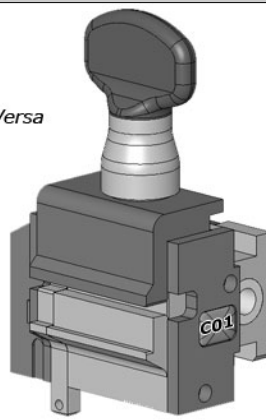

VERSA

HS3/HS4
 HS6/HS7

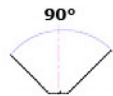

0.4 mm



RIC05044B
 Fresino V001
 Cutter V001
 Fräser V001
 Fraise V001
 Fresa V001

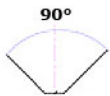

0.7 mm



RIC05618B
 Fresino V013
 Cutter V013
 Fräser V013
 Fraise V013
 Fresa V013

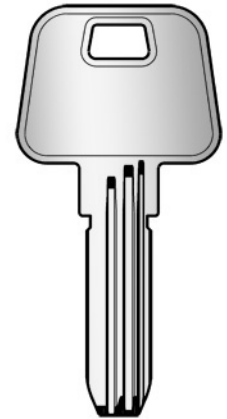

4-77

STANDARD



OPZ04879B
 Morsetto C01 Versa
 Jaw C01 Versa
 Spannbacken C01 Versa
 Étaux C01 Versa
 Mordaza C01 Versa

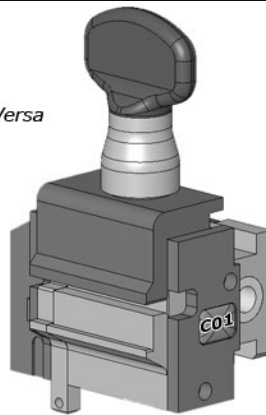

VERSA

HS3/4

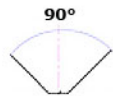

0.4 mm



RIC05044B
 Fresino V001
 Cutter V001
 Fräser V001
 Fraise V001
 Fresa V001

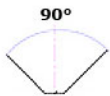

0.7 mm



RIC05618B
 Fresino V013
 Cutter V013
 Fräser V013
 Fraise V013
 Fresa V013



CX6



VERSA

STANDARD

code

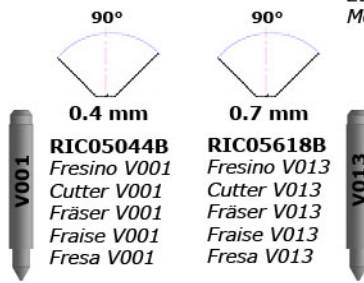

RIC05044B
Fresino V001
Cutter V001
Fräser V001
Fraise V001
Fresa V001

RIC05618B
Fresino V013
Cutter V013
Fräser V013
Fraise V013
Fresa V013

OPZ04879B
Morsetto C01 Versa
Jaw C01 Versa
Spannbacken C01 Versa
Étaux C01 Versa
Mordaza C01 Versa

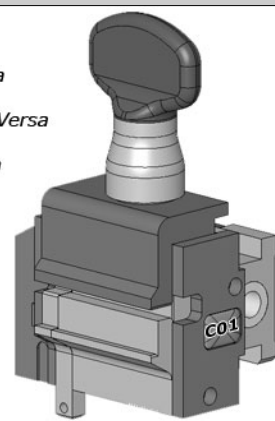

W50

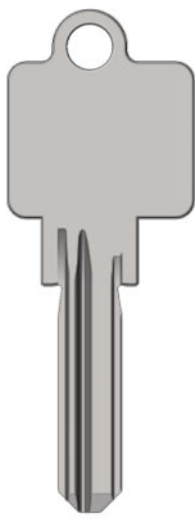

VERSA

OPTIONAL

code



RIC05750B
Fresino V017
Cutter V017
Fräser V017
Fraise V017
Fresa V017

OPZ05765B
Morsetto C05 Versa
Jaw C05 Versa
Spannbacken C05 Versa
Étaux C05 Versa
Mordaza C05 Versa

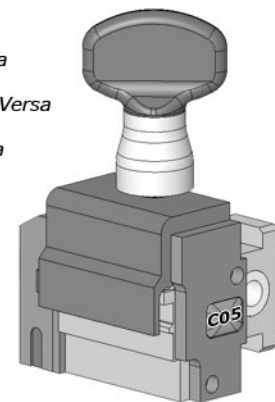

TO FIT :

OPTIONAL



OPZ05767B
 Morsetto C06 Versa
 Jaw C06 Versa
 Spannbacken C06 Versa
 Étaux C06 Versa
 Mordaza C06 Versa

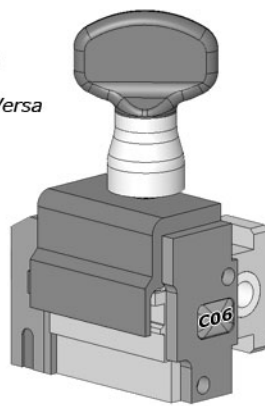

VERSA

W50 MK

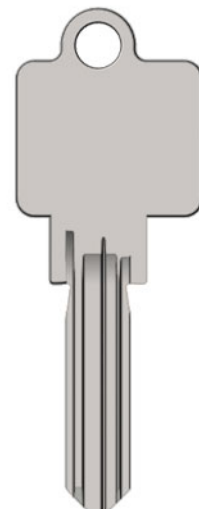

3 mm

RIC05750B
 Fresino V017
 Cutter V017
 Fräser V017
 Fraise V017
 Fresa V017



TO FIT :

BRICARD (F)

STANDARD



OPZ04879B
 Morsetto C01 Versa
 Jaw C01 Versa
 Spannbacken C01 Versa
 Étaux C01 Versa
 Mordaza C01 Versa

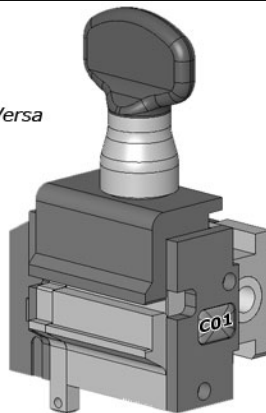

VERSA

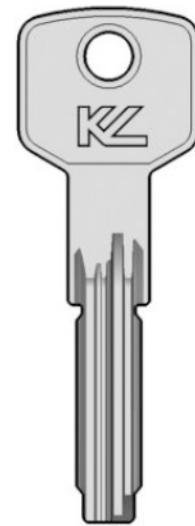

BD20



0.4 mm

RIC05044B
 Fresino V001
 Cutter V001
 Fräser V001
 Fraise V001
 Fresa V001

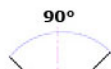

0.7 mm

RIC05618B
 Fresino V013
 Cutter V013
 Fräser V013
 Fraise V013
 Fresa V013



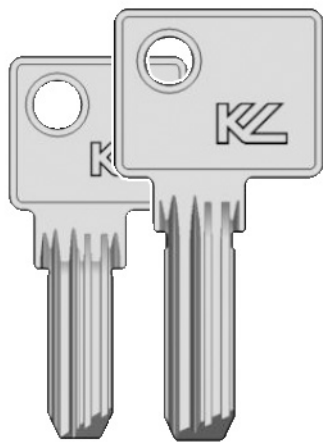

BU12 BU13



VERSA

STANDARD

code



0.4 mm
RIC05044B
Fresino V001
Cutter V001
Fräser V001
Fraise V001
Fresa V001



0.7 mm
RIC05618B
Fresino V013
Cutter V013
Fräser V013
Fraise V013
Fresa V013



V013

OPZ04879B
Morsetto C01 Versa
Jaw C01 Versa
Spannbacken C01 Versa
Étaux C01 Versa
Mordaza C01 Versa

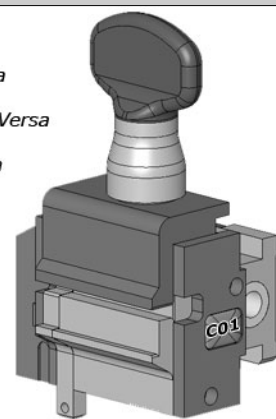

VERSA

STANDARD

code



0.4 mm
RIC05044B
Fresino V001
Cutter V001
Fräser V001
Fraise V001
Fresa V001



0.6 mm
RIC05612B
Fresino V014
Cutter V014
Fräser V014
Fraise V014
Fresa V014



V014

OPZ04879B
Morsetto C01 Versa
Jaw C01 Versa
Spannbacken C01 Versa
Étaux C01 Versa
Mordaza C01 Versa

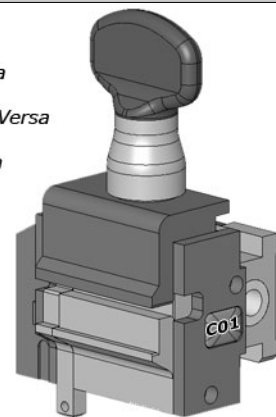

STANDARD

code

OPZ04879B
 Morsetto C01 Versa
 Jaw C01 Versa
 Spannbacken C01 Versa
 Étaux C01 Versa
 Mordaza C01 Versa

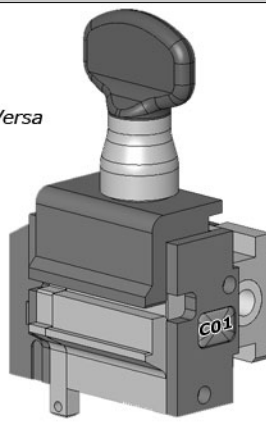

VERSA

WS



0.4 mm

RIC05044B
 Fresino V001
 Cutter V001
 Fräser V001
 Fraise V001
 Fresa V001



0.6 mm

RIC05612B
 Fresino V014
 Cutter V014
 Fräser V014
 Fraise V014
 Fresa V014



STANDARD

code

OPZ04879B
 Morsetto C01 Versa
 Jaw C01 Versa
 Spannbacken C01 Versa
 Étaux C01 Versa
 Mordaza C01 Versa

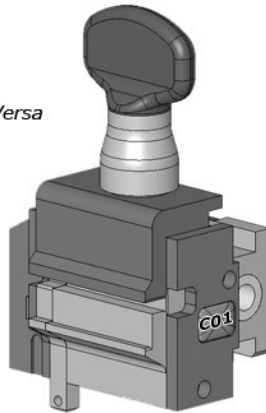

VERSA

ASTRAL



CA48

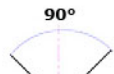

0.4 mm

RIC05044B
 Fresino V001
 Cutter V001
 Fräser V001
 Fraise V001
 Fresa V001



0.7 mm

RIC05618B
 Fresino V013
 Cutter V013
 Fräser V013
 Fraise V013
 Fresa V013



New Astral

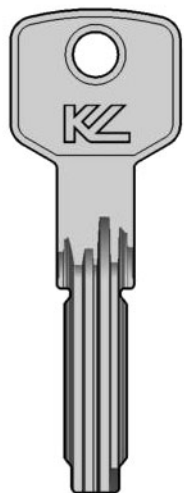

CA62



VERSA

STANDARD

 code



0.4 mm
RIC05044B
Fresino V001
Cutter V001
Fräser V001
Fraise V001
Fresa V001



0.7 mm
RIC05618B
Fresino V013
Cutter V013
Fräser V013
Fraise V013
Fresa V013



OPZ04879B
Morsetto C01 Versa
Jaw C01 Versa
Spannbacken C01 Versa
Étaux C01 Versa
Mordaza C01 Versa

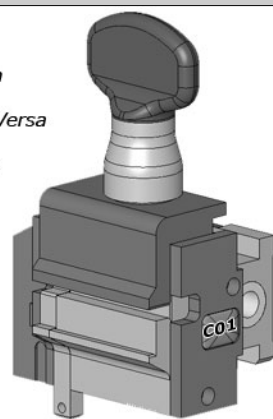

AXIS

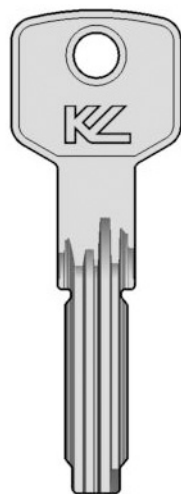

CA70



VERSA

STANDARD

 code



0.4 mm
RIC05044B
Fresino V001
Cutter V001
Fräser V001
Fraise V001
Fresa V001



0.7 mm
RIC05618B
Fresino V013
Cutter V013
Fräser V013
Fraise V013
Fresa V013



OPZ04879B
Morsetto C01 Versa
Jaw C01 Versa
Spannbacken C01 Versa
Étaux C01 Versa
Mordaza C01 Versa

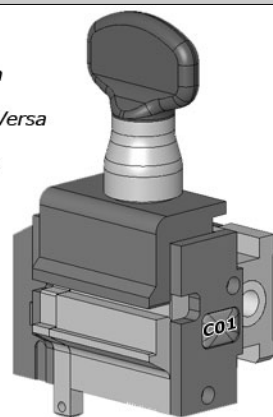

STANDARD

code

OPZ04879B
 Morsetto C01 Versa
 Jaw C01 Versa
 Spannbacken C01 Versa
 Étaux C01 Versa
 Mordaza C01 Versa

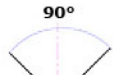
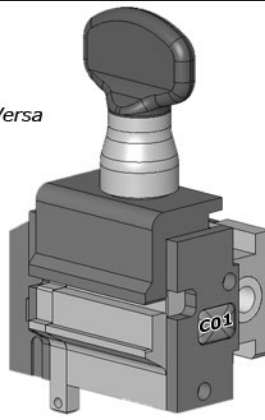

0.4 mm



RIC05044B
 Fresino V001
 Cutter V001
 Fräser V001
 Fraise V001
 Fresa V001



0.7 mm



RIC05618B
 Fresino V013
 Cutter V013
 Fräser V013
 Fraise V013
 Fresa V013



VERSA

Astral Tekno

ORIGINAL

OPTIONAL

code

OPZ08366B
 Morsetto C20 Versa
 Jaw C20 Versa
 Spannbacke C20 Versa
 Étau C20 Versa
 Mordaza C20 Versa

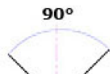

0.4 mm



RIC05044B
 Fresino V001
 Cutter V001
 Fräser V001
 Fraise V001
 Fresa V001



VERSA



STANDARD

code

OPZ04879B
 Morsetto C01 Versa
 Jaw C01 Versa
 Spannbacken C01 Versa
 Étaux C01 Versa
 Mordaza C01 Versa

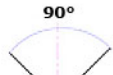
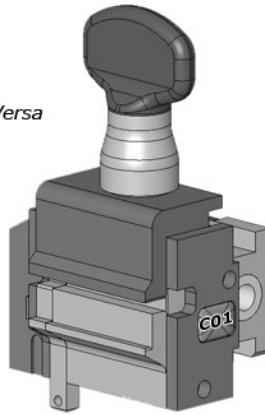

0.4 mm



RIC05044B
 Fresino V001
 Cutter V001
 Fräser V001
 Fraise V001
 Fresa V001



0.7 mm



RIC05618B
 Fresino V013
 Cutter V013
 Fräser V013
 Fraise V013
 Fresa V013



VERSA

AP3

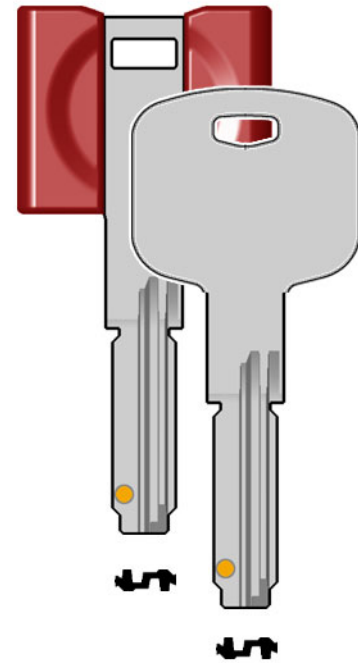

EUROSTAR



COR87



VERSA

STANDARD

code



OPZ04879B
Morsetto C01 Versa
Jaw C01 Versa
Spannbacken C01 Versa
Étaux C01 Versa
Mordaza C01 Versa

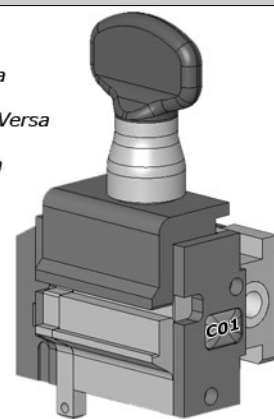

Goldstar



VERSA

STANDARD

code

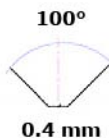

RIC05264B
Fresino V007
Cutter V007
Fräser V007
Fraise V007
Fresa V007

OPZ04879B
Morsetto C01 Versa
Jaw C01 Versa
Spannbacken C01 Versa
Étaux C01 Versa
Mordaza C01 Versa

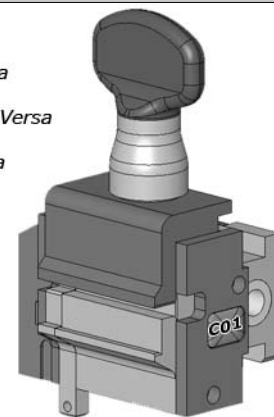

STANDARD

code

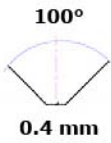

RIC05264B
Fresino V007
Cutter V007
Fräser V007
Fraise V007
Fresa V007

OPZ04879B
Morsetto C01 Versa
Jaw C01 Versa
Spannbacken C01 Versa
Étaux C01 Versa
Mordaza C01 Versa

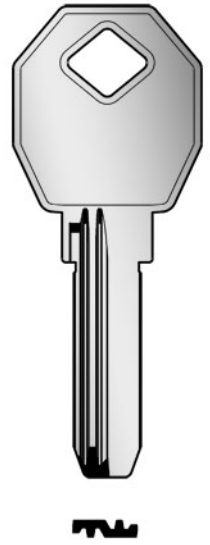
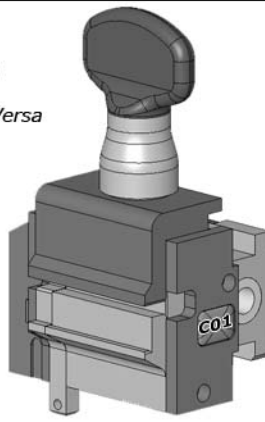

STANDARD

code

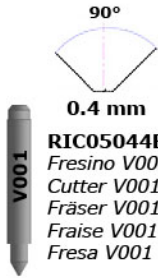

OPZ04879B
Morsetto C01 Versa
Jaw C01 Versa
Spannbacken C01 Versa
Étaux C01 Versa
Mordaza C01 Versa

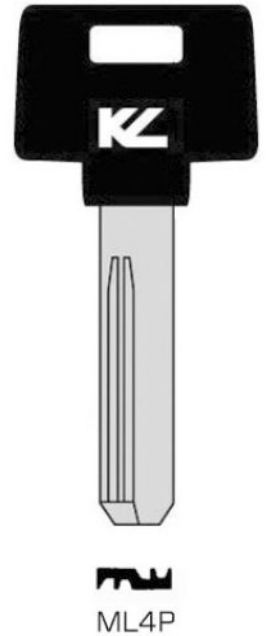
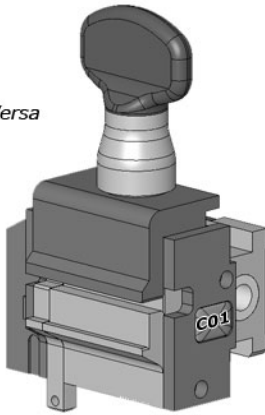

NEW POWER

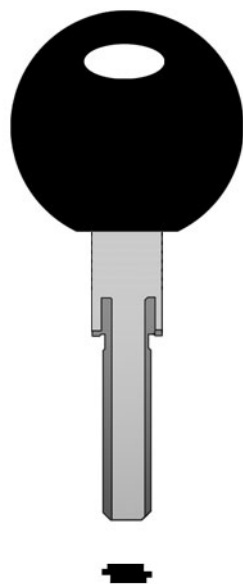

VERSA

STANDARD

code

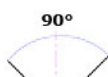

0.4 mm



RIC05044B
Fresino V001
Cutter V001
Fräser V001
Fraise V001
Fresa V001



2.26 mm



RIC06508B
Fresino V023
Cutter V023
Fräser V023
Fraise V023
Fresa V023



OPZ04879B
Morsetto C01 Versa
Jaw C01 Versa
Spannbacken C01 Versa
Étaux C01 Versa
Mordaza C01 Versa

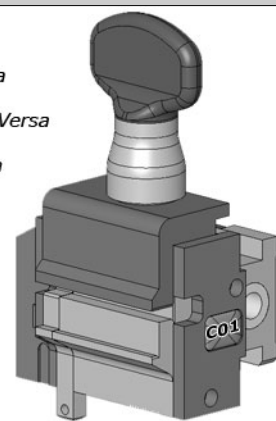

IX 5

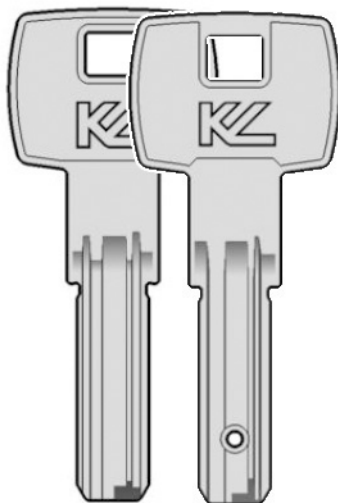

DO120 DO100X
DO100
DO24



VERSA

STANDARD

code

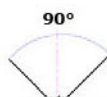

0.4 mm



RIC05044B
Fresino V001
Cutter V001
Fräser V001
Fraise V001
Fresa V001

OPTIONAL

code

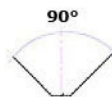

0.8 mm



RIC06104B
Fresino V021
Cutter V021
Fräser V021
Fraise V021
Fresa V021

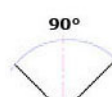

0.8 mm



RIC06368B
Fresino V022
Cutter V022
Fräser V022
Fraise V022
Fresa V022

OPZ04879B
Morsetto C01 Versa
Jaw C01 Versa
Spannbacke C01 Versa
Étau C01 Versa
Mordaza C01 Versa

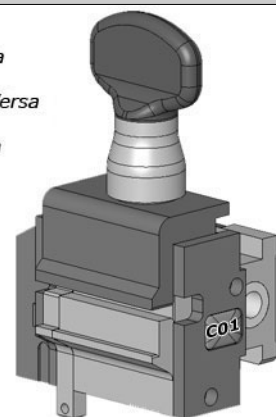

OPTIONAL

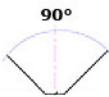

0.8 mm

RIC06104B
Fresino V021
Cutter V021
Fräser V021
Fraise V021
Fresa V021



OPZ05611B
Morsetto C02 Versa
Jaw C02 Versa
Spannbacken C02 Versa
Étaux C02 Versa
Mordaza C02 Versa

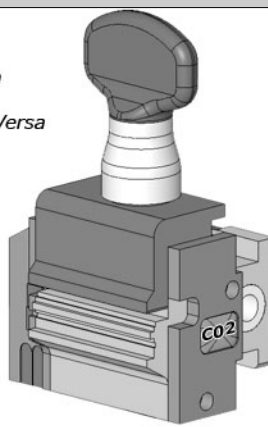

VERSA

IX 6

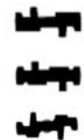

(121)

OPTIONAL



0.8 mm

RIC06104B
Fresino V021
Cutter V021
Fräser V021
Fraise V021
Fresa V021



OPZ05701B
Morsetto C03 Versa
Jaw C03 Versa
Spannbacken C03 Versa
Étaux C03 Versa
Mordaza C03 Versa

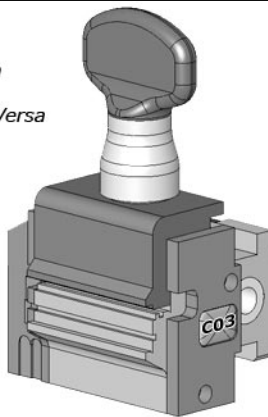

VERSA

IX6 SR

IX5DAS



(132)
(232)
(233)



(038)

DS10
DS15

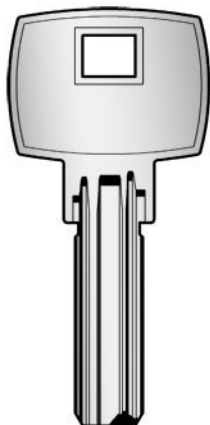

IX10



VERSA

OPTIONAL

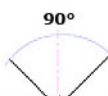

0.8 mm



RIC06368B
Fresino V022
Cutter V022
Fräser V022
Fraise V022
Fresa V022

PROTECTED SYSTEM



OPZ04879B
Morsetto C01 Versa
Jaw C01 Versa
Spannbacken C01 Versa
Étaux C01 Versa
Mordaza C01 Versa

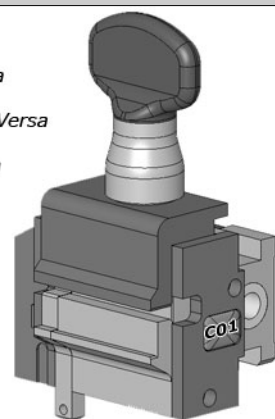

RS8

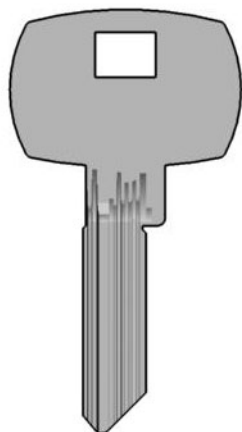

VERSA

OPTIONAL

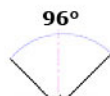

0.4 mm

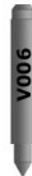

RIC05262B
Fresino V006
Cutter V006
Fräser V006
Fraise V006
Fresa V006

OPZ07332B
Morsetto C14 Versa
Jaw C14 Versa
Spannbacken C14 Versa
Étaux C14 Versa
Mordaza C14 Versa

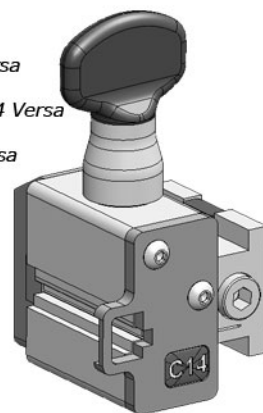

OPTIONAL

code

OPZ07204B

Morsetto C12 Versa
Jaw C12 Versa
Spannbacke C12 Versa
Étau C12 Versa
Mordaza C12 Versa

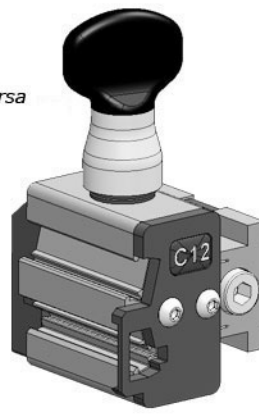

VERSA

SIGMA

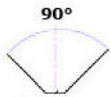
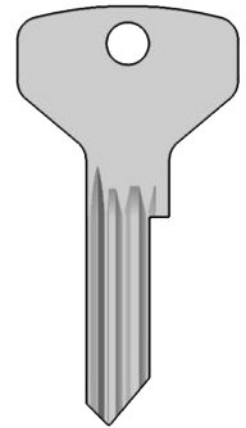

0.4 mm

RIC05044B
Fresino V001
Cutter V001
Fräser V001
Fraise V001
Fresa V001
STANDARD

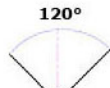

0.3 mm

RIC05272B
Fresino V011
Cutter V011
Fräser V011
Fraise V011
Fresa V011

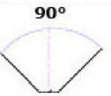
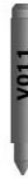

0.7 mm

RIC05618B
Fresino V013
Cutter V013
Fräser V013
Fraise V013
Fresa V013

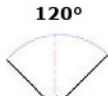

0.8 mm

RIC07785B
Fresino V034
Cutter V034
Fräser V034
Fraise V034
Fresa V034



OPTIONAL

code

OPZ04879B

Morsetto C01 Versa
Jaw C01 Versa
Spannbacken C01 Versa
Étaux C01 Versa
Mordaza C01 Versa

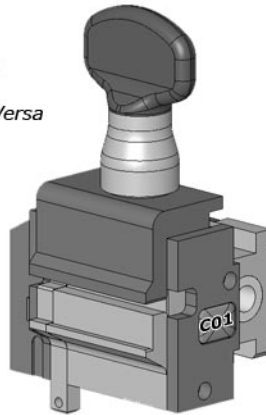

VERSA

IXDAS

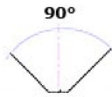
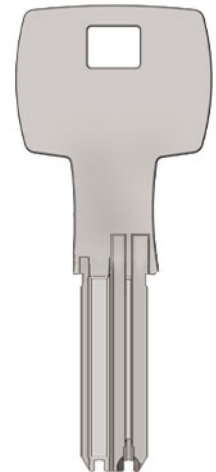

0.8 mm

RIC06104B
Fresino V021
Cutter V021
Fräser V021
Fraise V021
Fresa V021



PROTECTED
SYSTEM



IXEZ

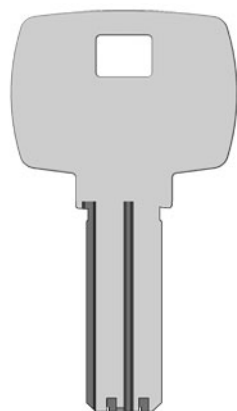

(51)



VERSA

STANDARD

code



0.4 mm



RIC05044B
Fresino V001
Cutter V001
Fräser V001
Fraise V001
Fresa V001



0.6 mm



RIC05612B
Fresino V014
Cutter V014
Fräser V014
Fraise V014
Fresa V014

OPZ04879B
Morsetto C01 Versa
Jaw C01 Versa
Spannbacken C01 Versa
Étaux C01 Versa
Mordaza C01 Versa

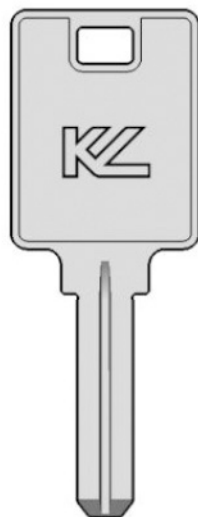
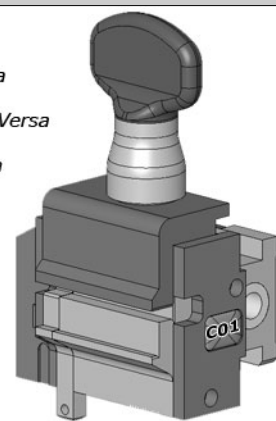

DS 1



VERSA

STANDARD

code

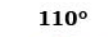

0.3 mm



RIC05270B
Fresino V010
Cutter V010
Fräser V010
Fraise V010
Fresa V010

OPZ04879B
Morsetto C01 Versa
Jaw C01 Versa
Spannbacken C01 Versa
Étaux C01 Versa
Mordaza C01 Versa

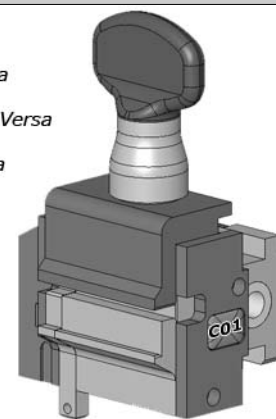

OPTIONAL

code



OPZ06039B
Morsetto C08
Jaw C08
Spannbacke C08
Étau C08
Mordaza C08



RIC05266B
Fresino V008
Cutter V008
Fräser V008
Fraise V008
Fresa V008

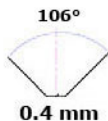

VERSA

DCN



OPTIONAL

code

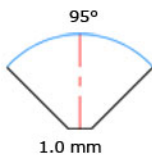

RIC08161B
Fresino V039
Cutter V039
Fräser V039
Fraise V039
Fresa V039

OPZ08107B
Morsetto C16 Versa
Jaw C16 Versa
Spannbacken C16 Versa
Étaux C16 Versa
Mordaza C16 Versa



VERSA

OMEGA

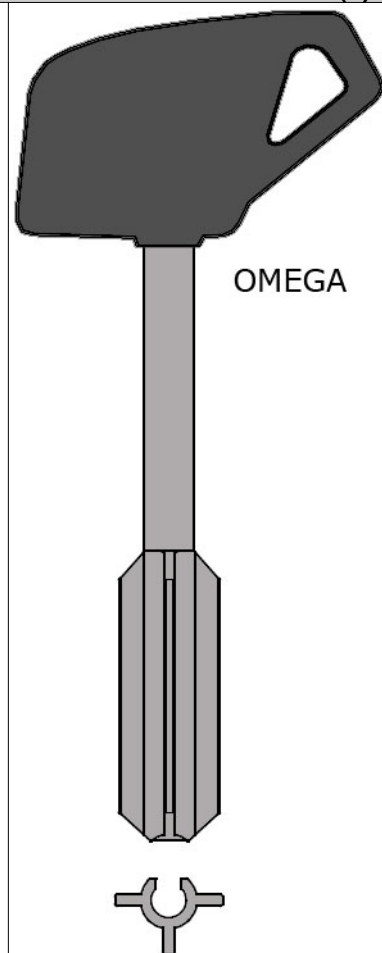



EU8



VERSA

STANDARD

code



2.3 mm

RIC05616B
 Fresino V016
 Cutter V016
 Fräser V016
 Fraise V016
 Fresa V016

OPZ04879B
 Morsetto C01 Versa
 Jaw C01 Versa
 Spannbacken C01 Versa
 Étaux C01 Versa
 Mordaza C01 Versa

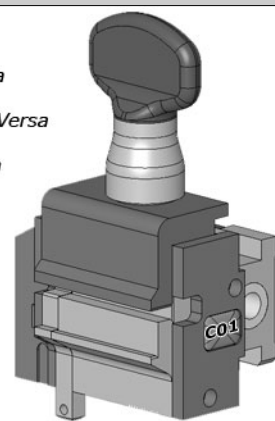

DPI /DPS

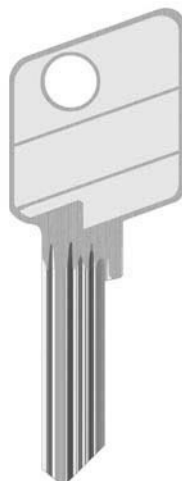

EVVA



VERSA

OPTIONAL

CODE

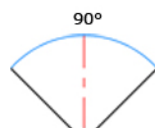

0.40 mm

RIC05044B
 Fresino V001
 Cutter V001
 Fräser V001
 Fraise V001
 Fresa V001
STANDARD

OR

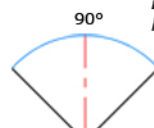

0.70 mm

RIC05618B
 Fresino V013
 Cutter V013
 Fräser V013
 Fraise V013
 Fresa V013
OPTIONAL

OPZ06039B
 Morsetto C08 Versa
 Jaw C08 Versa
 Spannbacken C08 Versa
 Étaux C08 Versa
 Mordaza C08 Versa



STANDARD



OPZ04879B
 Morsetto C01 Versa
 Jaw C01 Versa
 Spannbacken C01 Versa
 Étaux C01 Versa
 Mordaza C01 Versa

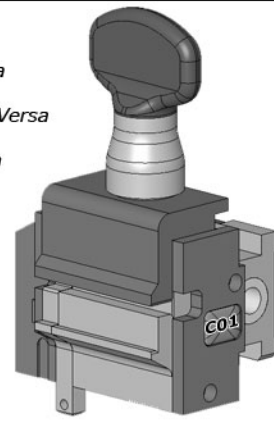

VERSA

3KS

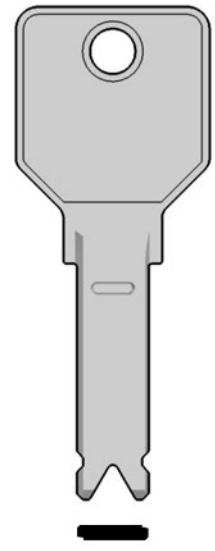

1.28 mm

RIC06102B
 Fresino V020
 Cutter V020
 Fräser V020
 Fraise V020
 Fresa V020



VERSA

OPTIONAL



OPZ08107B
 Morsetto C15 Versa
 Jaw C15 Versa
 Spannbacken C15 Versa
 Étaux C15 Versa
 Mordaza C15 Versa

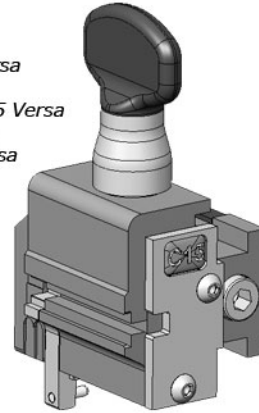

VERSA

ICS

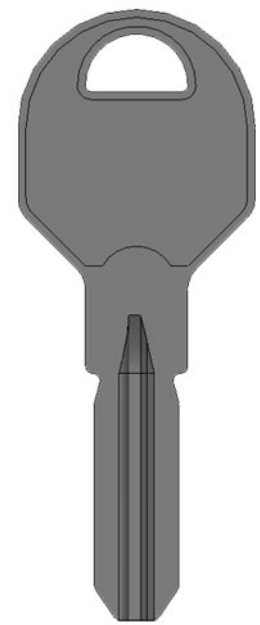

2.00 mm

RIC07786B
 Fresino V037
 Cutter V037
 Fräser V037
 Fraise V037
 Fresa V037

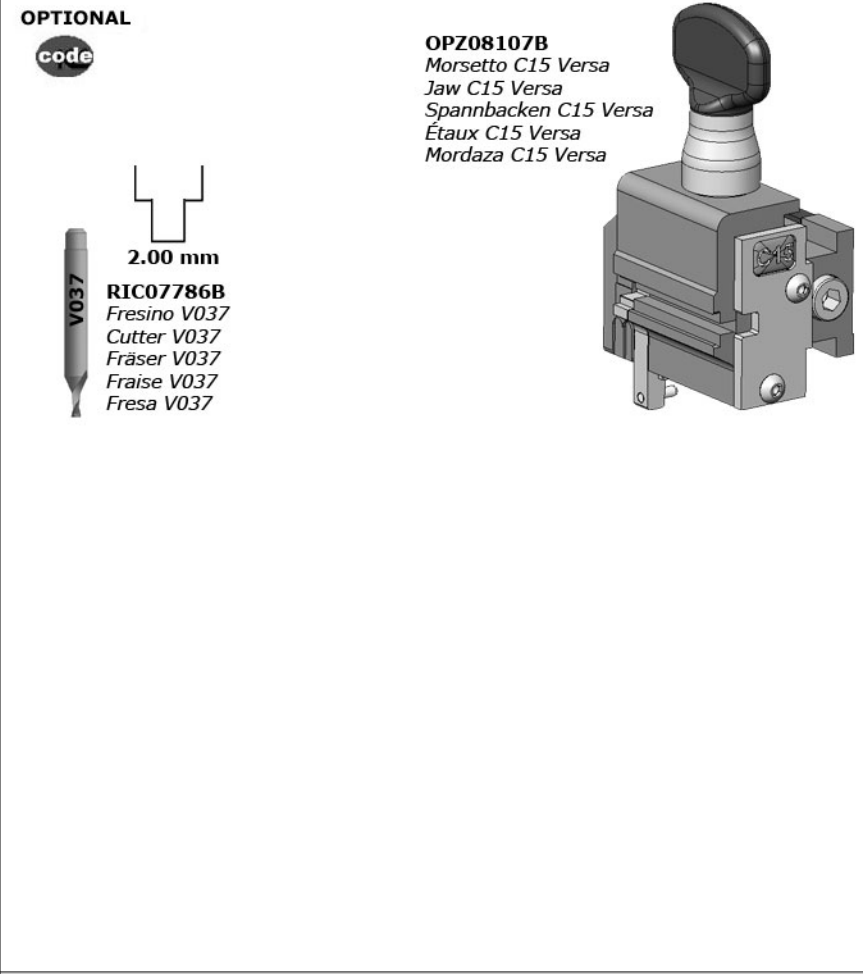

DS10
DS15

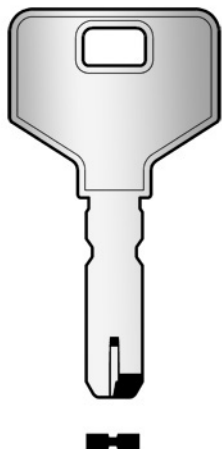

STANDARD

code



RIC05084B
Fresino V004
Cutter V004
Fräser V004
Fraise V004
Fresa V004

OPZ04879B
Morsetto C01 Versa
Jaw C01 Versa
Spannbacken C01 Versa
Étaux C01 Versa
Mordaza C01 Versa

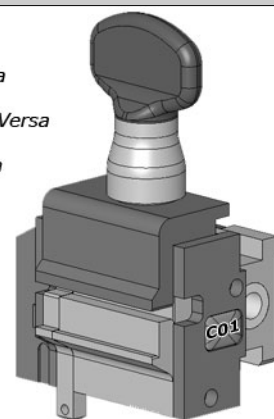

DS-15 2A

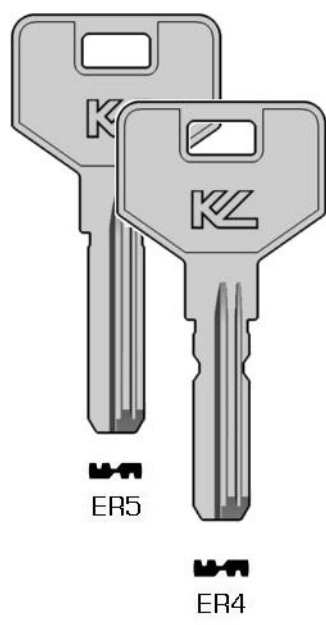

STANDARD

code



RIC05084B
Fresino V004
Cutter V004
Fräser V004
Fraise V004
Fresa V004

OPZ04879B
Morsetto C01 Versa
Jaw C01 Versa
Spannbacken C01 Versa
Étaux C01 Versa
Mordaza C01 Versa

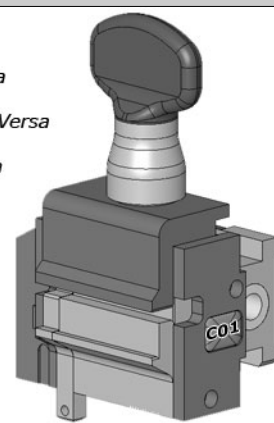

STANDARD

code

OPZ04879B
 Morsetto C01 Versa
 Jaw C01 Versa
 Spannbacken C01 Versa
 Étaux C01 Versa
 Mordaza C01 Versa

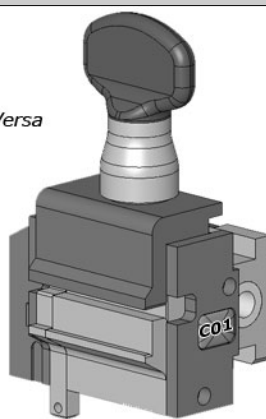

VERSA

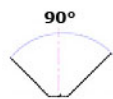

0.4 mm

**RIC05044B**

Fresino V001
 Cutter V001
 Fräser V001
 Fraise V001
 Fresa V001

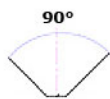

0.7 mm

**RIC05618B**

Fresino V013
 Cutter V013
 Fräser V013
 Fraise V013
 Fresa V013



STANDARD

code

OPZ04879B
 Morsetto C01 Versa
 Jaw C01 Versa
 Spannbacken C01 Versa
 Étaux C01 Versa
 Mordaza C01 Versa

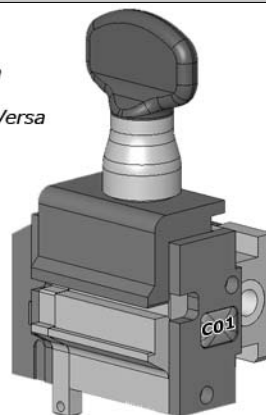

VERSA

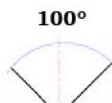

0.4 mm

**RIC05264B**

Fresino V007
 Cutter V007
 Fräser V007
 Fraise V007
 Fresa V007



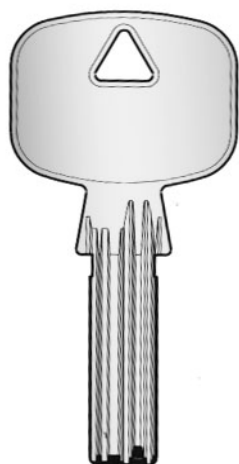

VERSA

STANDARD

code

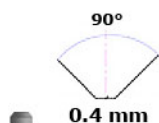

0.4 mm



RIC05044B

Fresino V001
Cutter V001
Fräser V001
Fraise V001
Fresa V001

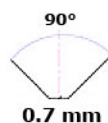

0.7 mm



RIC05618B

Fresino V013
Cutter V013
Fräser V013
Fraise V013
Fresa V013

OPZ04879B
Morsetto C01 Versa
Jaw C01 Versa
Spannbacken C01 Versa
Étaux C01 Versa
Mordaza C01 Versa

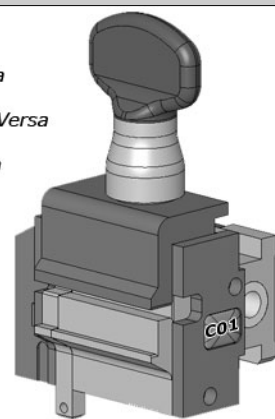

ATLANTIC
TRANSIT

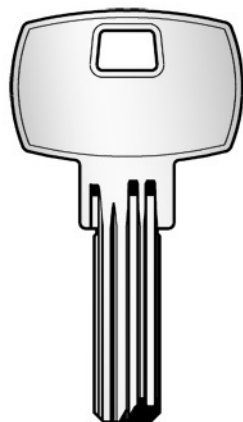

VERSA

STANDARD

code



0.4 mm



RIC05044B

Fresino V001
Cutter V001
Fräser V001
Fraise V001
Fresa V001



0.6 mm



RIC05612B

Fresino V014
Cutter V014
Fräser V014
Fraise V014
Fresa V014

OPZ04879B
Morsetto C01 Versa
Jaw C01 Versa
Spannbacken C01 Versa
Étaux C01 Versa
Mordaza C01 Versa

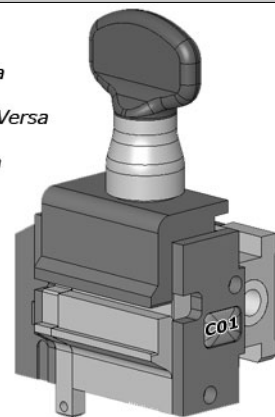

STANDARD

code

96°



0.4 mm

**RIC05262B**

Fresino V006

Cutter V006

Fräser V006

Fraise V006

Fresa V006

OPTIONAL

OPZ04879B

Morsetto C01 Versa

Jaw C01 Versa

Spannbacke C01 Versa

Étau C01 Versa

Mordaza C01 Versa

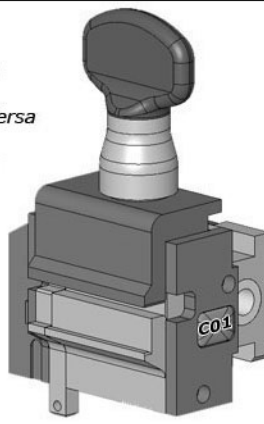

VERSA

WS
WS X
WS XP

ORIGINAL

WSG PLUS
WSG X
WSG XP

STANDARD

code

90°



0.4 mm

**RIC05044B**

Fresino V001

Cutter V001

Fräser V001

Fraise V001

Fresa V001

OPZ04879B

Morsetto C01 Versa

Jaw C01 Versa

Spannbacke C01 Versa

Étau C01 Versa

Mordaza C01 Versa

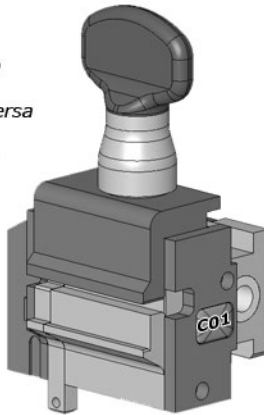

VERSA

V18
V9

ORIGINAL

OPTIONAL

code

90°



0.7 mm

RIC05618B

Fresino V013

Cutter V013

Fräser V013

Fraise V013

Fresa V013



90°



0.6 mm

RIC05612B

Fresino V014

Cutter V014

Fräser V014

Fraise V014

Fresa V014



ORIGINAL



VERSA

STANDARD

code

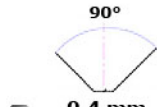

RIC05044B
Fresino V001
Cutter V001
Fräser V001
Fraise V001
Fresa V001

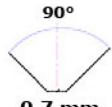

RIC05618B
Fresino V013
Cutter V013
Fräser V013
Fraise V013
Fresa V013



OPZ04879B
Morsetto C01 Versa
Jaw C01 Versa
Spannbacken C01 Versa
Étaux C01 Versa
Mordaza C01 Versa

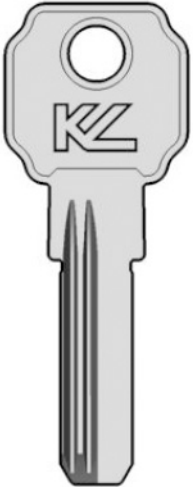
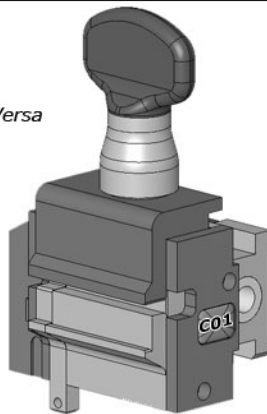

IC 1



VERSA

STANDARD

code

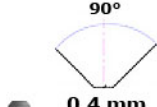

RIC05044B
Fresino V001
Cutter V001
Fräser V001
Fraise V001
Fresa V001

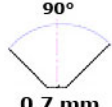

RIC05618B
Fresino V013
Cutter V013
Fräser V013
Fraise V013
Fresa V013



OPZ04879B
Morsetto C01 Versa
Jaw C01 Versa
Spannbacken C01 Versa
Étaux C01 Versa
Mordaza C01 Versa

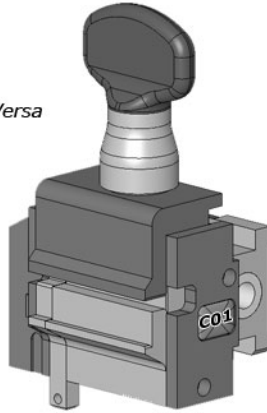

STANDARD



OPZ04879B
 Morsetto C01 Versa
 Jaw C01 Versa
 Spannbacken C01 Versa
 Étaux C01 Versa
 Mordaza C01 Versa

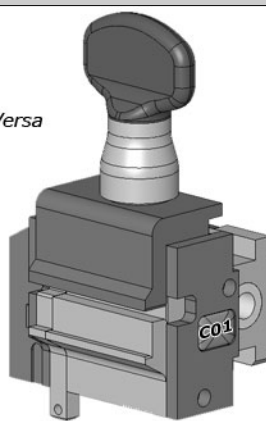

VERSA

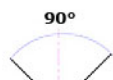

0.4 mm



RIC05044B
 Fresino V001
 Cutter V001
 Fräser V001
 Fraise V001
 Fresa V001

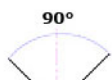

0.6 mm



RIC05612B
 Fresino V014
 Cutter V014
 Fräser V014
 Fraise V014
 Fresa V014

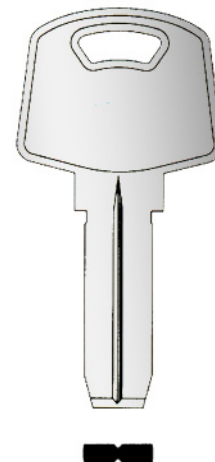

STANDARD



OPZ04879B
 Morsetto C01 Versa
 Jaw C01 Versa
 Spannbacken C01 Versa
 Étaux C01 Versa
 Mordaza C01 Versa

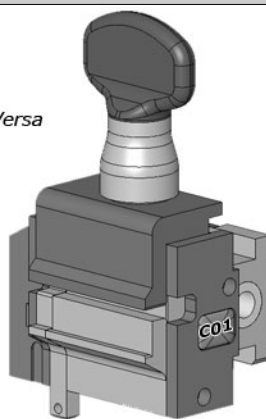

VERSA

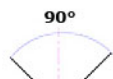

0.4 mm



RIC05044B
 Fresino V001
 Cutter V001
 Fräser V001
 Fraise V001
 Fresa V001



0.6 mm



RIC05612B
 Fresino V014
 Cutter V014
 Fräser V014
 Fraise V014
 Fresa V014

R6 R11

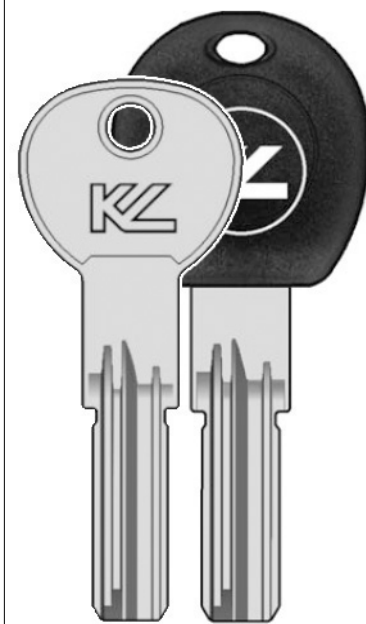

HNH HNH
 ISE14 ISE17P
 ISE15 ISE15P
 ISE17 ISE14P

CSR



VERSA

STANDARD

code

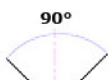

0.4 mm



RIC05044B
Fresino V001
Cutter V001
Fräser V001
Fraise V001
Fresa V001

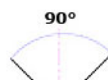

0.6 mm



RIC05612B
Fresino V014
Cutter V014
Fräser V014
Fraise V014
Fresa V014

OPZ04879B
Morsetto C01 Versa
Jaw C01 Versa
Spannbacken C01 Versa
Étaux C01 Versa
Mordaza C01 Versa

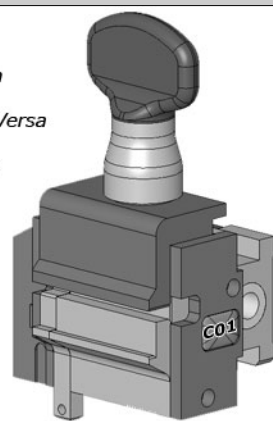

ORIGINAL



I01



VERSA

STANDARD

code

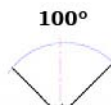

0.4 mm



RIC05264B
Fresino V007
Cutter V007
Fräser V007
Fraise V007
Fresa V007

OPZ04879B
Morsetto C01 Versa
Jaw C01 Versa
Spannbacken C01 Versa
Étaux C01 Versa
Mordaza C01 Versa

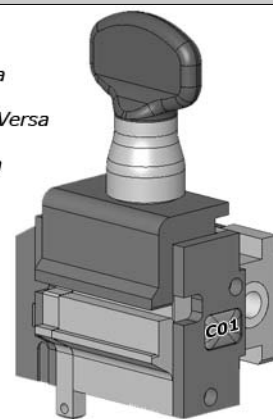

ORIGINAL

STANDARD

code

OPZ04879B
 Morsetto C01 Versa
 Jaw C01 Versa
 Spannbacken C01 Versa
 Étaux C01 Versa
 Mordaza C01 Versa

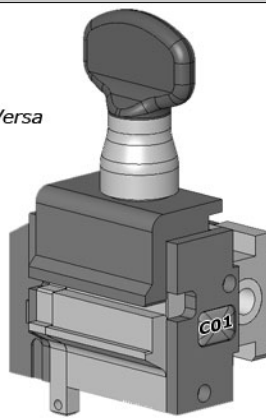

VERSA

KABA 8



KA1

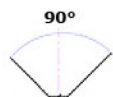

0.4 mm

**RIC05044B**

Fresino V001
 Cutter V001
 Fräser V001
 Fraise V001
 Fresa V001

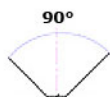

0.7 mm

**RIC05618B**

Fresino V013
 Cutter V013
 Fräser V013
 Fraise V013
 Fresa V013

OPTIONAL

CODE

OPZ06541B
 Morsetto C21 Versa
 Jaw C21 Versa
 Spannbacken C21 Versa
 Étaux C21 Versa
 Mordaza C21 Versa



VERSA

EXPER T



0.4 mm

**RIC05044B**

Fresino V001
 Cutter V001
 Fräser V001
 Fraise V001
 Fresa V001

**INCLUDED WITH JAW**

Tastatore T005
 Tracer Point T005
 Taster T005
 Palpeur T005
 Palpador T005

KABA MICRO

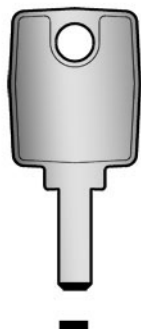

VERSA

OPTIONAL

CODE

90°



0.4 mm

RIC05044B

Fresino V001
Cutter V001
Fräser V001
Fraise V001
Fresa V001

STANDARD



OPZ07800B

Morsetto C15 Versa
Jaw C15 Versa
Spannbacke C15 Versa
Étau C15 Versa
Mordaza C15 Versa

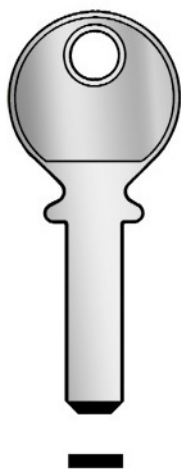
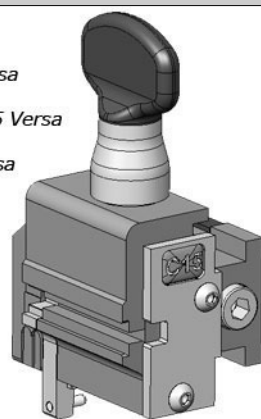

MINI KABA



VERSA

STANDARD

code

90°



0.4 mm

RIC05044B

Fresino V001
Cutter V001
Fräser V001
Fraise V001
Fresa V001



90°



0.7 mm

RIC05618B

Fresino V013
Cutter V013
Fräser V013
Fraise V013
Fresa V013



OPZ04879B

Morsetto C01 Versa
Jaw C01 Versa
Spannbacken C01 Versa
Étaux C01 Versa
Mordaza C01 Versa

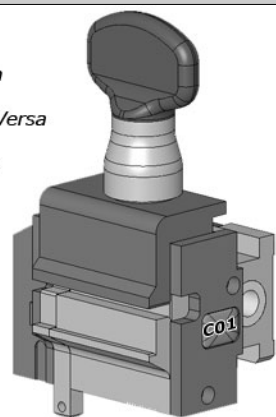

OPTIONAL

code



OPZ08107B
Morsetto C15 Versa
Jaw C15 Versa
Spannbacke C15 Versa
Étau C15 Versa
Mordaza C15 Versa

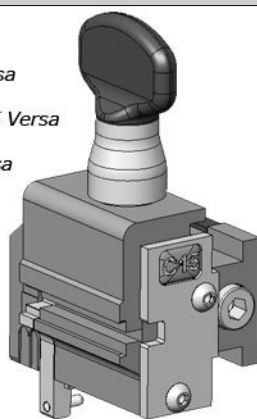

VERSA

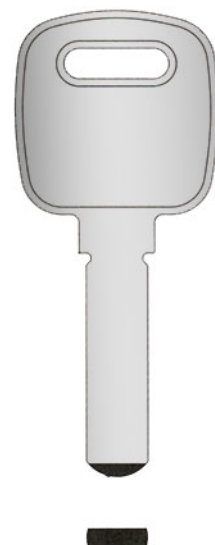

STANDARD

code

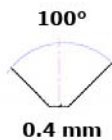

RIC05264B
Fresino V007
Cutter V007
Fräser V007
Fraise V007
Fresa V007

OPZ04879B
Morsetto C01 Versa
Jaw C01 Versa
Spannbacken C01 Versa
Étaux C01 Versa
Mordaza C01 Versa

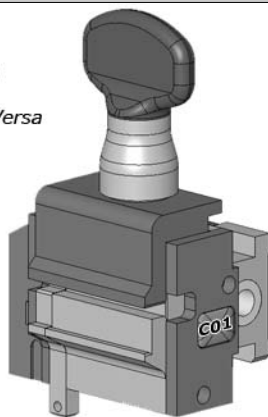

VERSA



ORIGINAL



VERSA

OPTIONAL

code

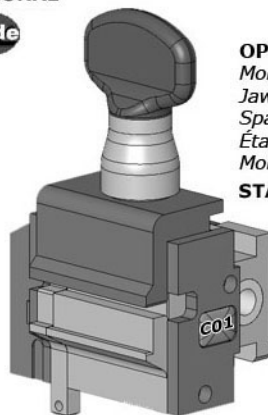

OPZ04879B
 Morsetto C01 Versa
 Jaw C01 Versa
 Spannbacke C01 Versa
 Étau C01 Versa
 Mordaza C01 Versa

STANDARD



RIC05266B
 Fresino V008
 Cutter V008
 Fräser V008
 Fraise V008
 Fresa V008

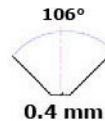

KYR1



VERSA

OPTIONAL

CODE



RIC05044B
 Fresino V001
 Cutter V001
 Fräser V001
 Fraise V001
 Fresa V001

STANDARD

OPZ07800B
 Morsetto C15 Versa
 Jaw C15 Versa
 Spannbacke C15 Versa
 Étau C15 Versa
 Mordaza C15 Versa

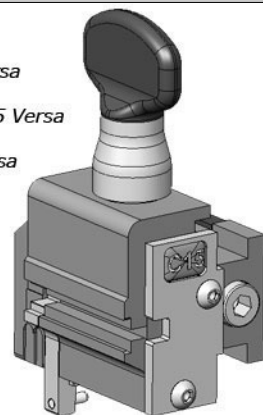

STANDARD

code

82°

0.5 mm

RIC05084B

Fresino V004

Cutter V004

Fräser V004

Fraise V004

Fresa V004

V004

OPZ04879B

Morsetto C01 Versa

Jaw C01 Versa

Spannbacken C01 Versa

Étaux C01 Versa

Mordaza C01 Versa

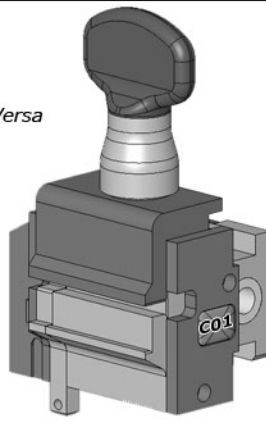

VERSAS

2000



KS13

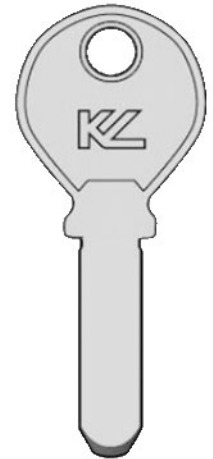

KS2

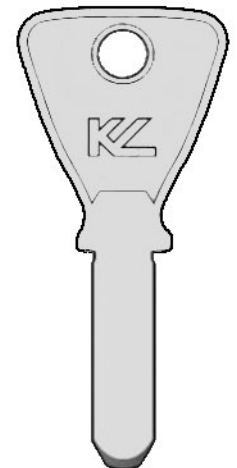

KS3

1000

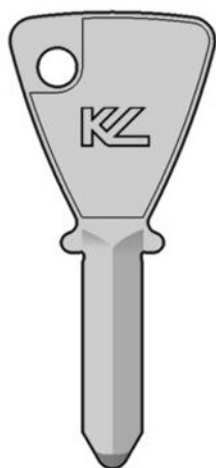

KS1



VERSA

OPTIONAL

code

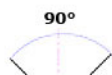

0.4 mm



RIC05044B
Fresino V001
Cutter V001
Fräser V001
Fraise V001
Fresa V001

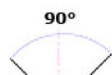

0.7 mm



RIC05618B
Fresino V013
Cutter V013
Fräser V013
Fraise V013
Fresa V013

OPZ06711B
Morsetto C11 Versa
Jaw C11 Versa
Spannbacken C11 Versa
Étaux C11 Versa
Mordaza C11 Versa

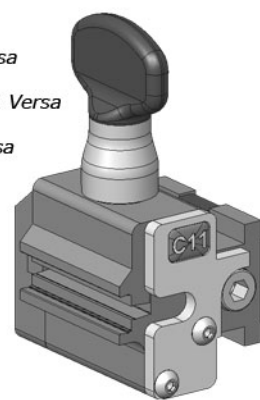

XA/XB/XC
XD/XE

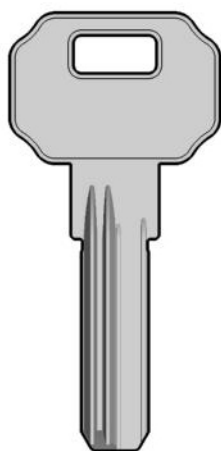

KS1



VERSA

OPTIONAL

code

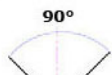

0.4 mm



RIC05044B
Fresino V001
Cutter V001
Fräser V001
Fraise V001
Fresa V001

STANDARD

OPZ05701B
Morsetto C03 Versa
Jaw C03 Versa
Spannbacke C03 Versa
Étau C03 Versa
Mordaza C03 Versa

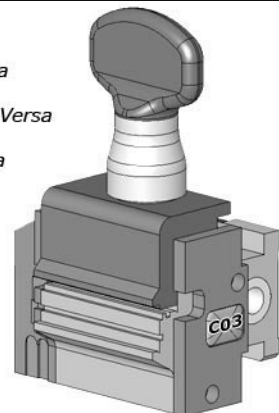

OPTIONAL

code

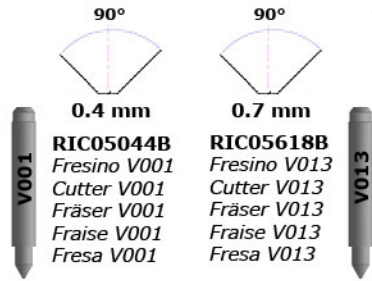

OPZ06711B
 Morsetto C11 Versa
 Jaw C11 Versa
 Spannbacken C11 Versa
 Étaux C11 Versa
 Mordaza C11 Versa

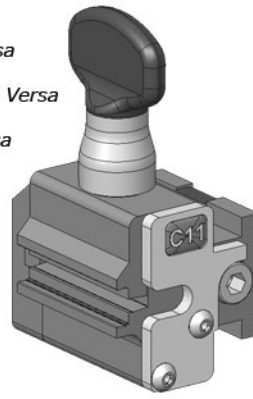

VERSA



LI11

STANDARD

code



OPZ04879B
 Morsetto C01 Versa
 Jaw C01 Versa
 Spannbacken C01 Versa
 Étaux C01 Versa
 Mordaza C01 Versa

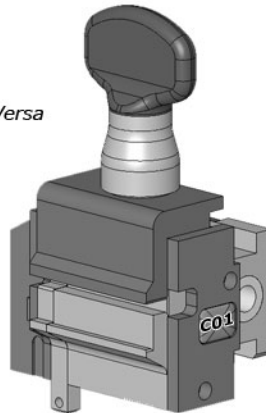

VERSA

2000

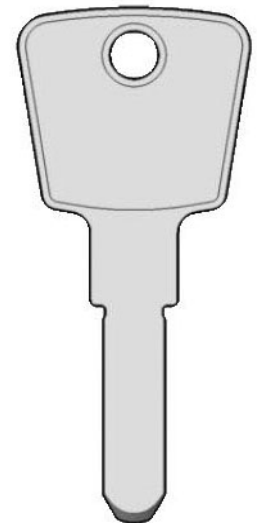



OPTIONAL

CODE

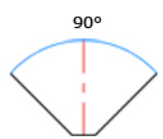

RIC05044B
Fresino V001
Cutter V001
Fräser V001
Fraise V001
Fresa V001

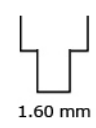

RIC09211B
Fresino V043
Cutter V043
Fräser V043
Fraise V043
Fresa V043

OPZ09240B
Morsetto C24 Versa
Jaw C24 Versa
Spannbacken C24 Versa
Étaux C24 Versa
Mordaza C24 Versa

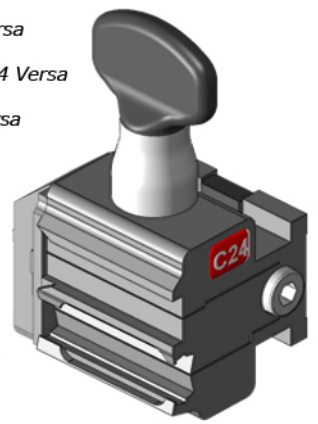

INCLUDED WITH JAW
Tastatore T005
Tracer Point T005
Taster T005
Palpeur T005
Palpador T005

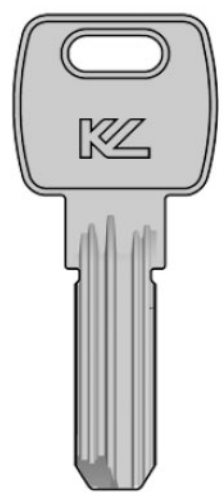

MC15S



STANDARD

code

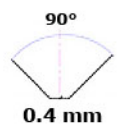

RIC05044B
Fresino V001
Cutter V001
Fräser V001
Fraise V001
Fresa V001



RIC05612B
Fresino V014
Cutter V014
Fräser V014
Fraise V014
Fresa V014

OPZ04879B
Morsetto C01 Versa
Jaw C01 Versa
Spannbacken C01 Versa
Étaux C01 Versa
Mordaza C01 Versa

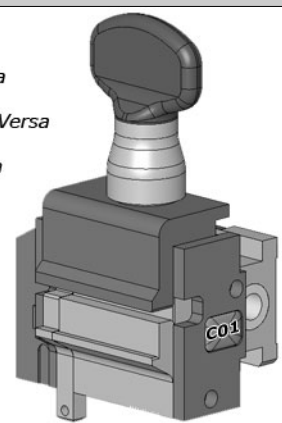

OPTIONAL

code

87°



0.87 mm

RIC07785B

Fresino V036
Cutter V036
Fräser V036
Fraise V036
Fresa V036



OPZ08204B

Morsetto C09 Versa
Jaw C09Versa
Spannbacken C09 Versa
Étaux C09 Versa
Mordaza C09 Versa

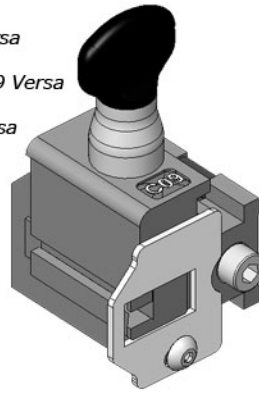

VERSA

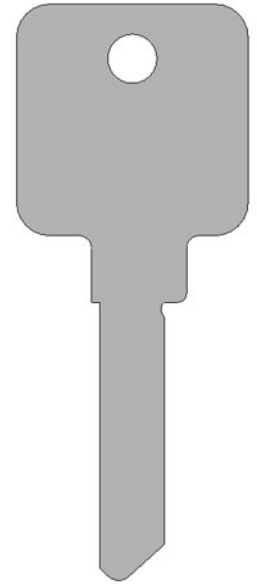

STANDARD

code

90°



0.4 mm

RIC05044B

Fresino V001
Cutter V001
Fräser V001
Fraise V001
Fresa V001



90°



0.7 mm

RIC05618B

Fresino V013
Cutter V013
Fräser V013
Fraise V013
Fresa V013



OPZ04879B

Morsetto C01 Versa
Jaw C01 Versa
Spannbacken C01 Versa
Étaux C01 Versa
Mordaza C01 Versa

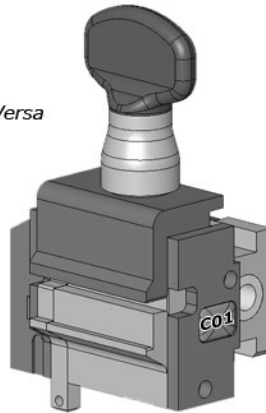

VERSA

HS

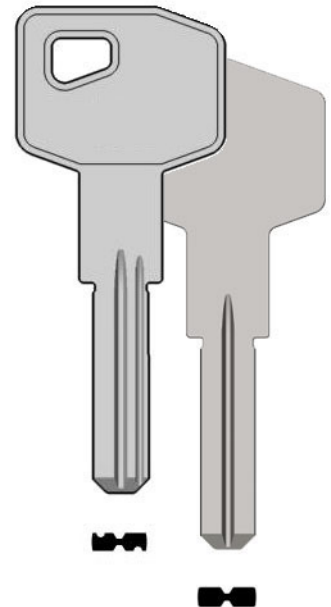

X8

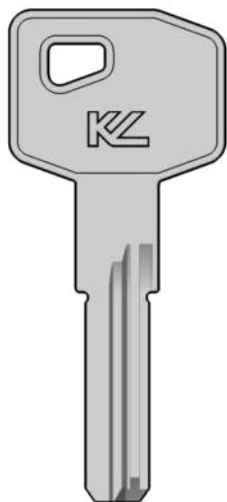

VERSA

STANDARD

code



0.4 mm



RIC05044B
Fresino V001
Cutter V001
Fräser V001
Fraise V001
Fresa V001

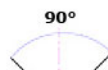

0.7 mm

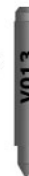

RIC05618B
Fresino V013
Cutter V013
Fräser V013
Fraise V013
Fresa V013

OPZ04879B

Morsetto C01 Versa
Jaw C01 Versa
Spannbacken C01 Versa
Étaux C01 Versa
Mordaza C01 Versa

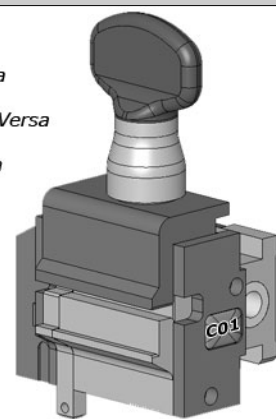

HSP



VERSA

OPTIONAL

code



4 mm



RIC05044B
Fresino V001
Cutter V001
Fräser V001
Fraise V001
Fresa V001



OPZ05703B

Morsetto C04 Versa
Jaw C04 Versa
Spannbacken C04 Versa
Étaux C04 Versa
Mordaza C04 Versa

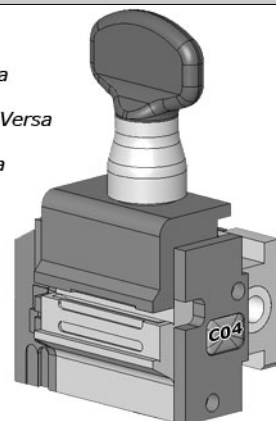

STANDARD



OPZ04879B
 Morsetto C01 Versa
 Jaw C01 Versa
 Spannbacken C01 Versa
 Étaux C01 Versa
 Mordaza C01 Versa

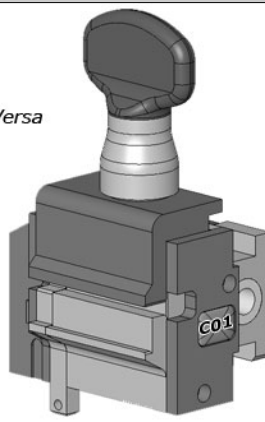

VERSA

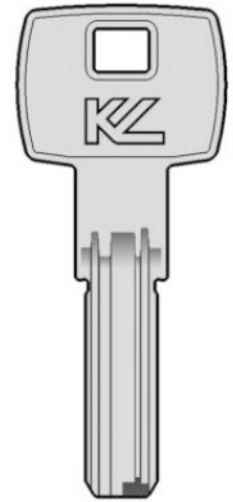

 MR1

90°
 0.4 mm
RIC05044B
 Fresino V001
 Cutter V001
 Fräser V001
 Fraise V001
 Fresa V001

90°
 0.7 mm
RIC05618B
 Fresino V013
 Cutter V013
 Fräser V013
 Fraise V013
 Fresa V013

V001

V013

STANDARD



OPZ04879B
 Morsetto C01 Versa
 Jaw C01 Versa
 Spannbacken C01 Versa
 Étaux C01 Versa
 Mordaza C01 Versa

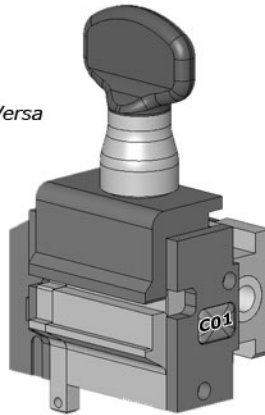

VERSA

CHAMPIONS



82°
 0.5 mm
RIC05084B
 Fresino V004
 Cutter V004
 Fräser V004
 Fraise V004
 Fresa V004

V004

DEFENDER



VERSA

STANDARD

code

100°



0.4 mm

OPZ04879B

Morsetto C01 Versa
Jaw C01 Versa
Spannbacken C01 Versa
Étaux C01 Versa
Mordaza C01 Versa

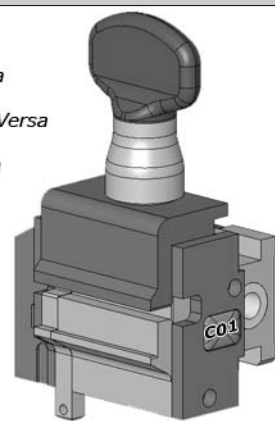

RIC05264B

Fresino V007
Cutter V007
Fräser V007
Fraise V007
Fresa V007



ORIGINAL



VERSA

STANDARD

code

100°



0.4 mm

OPZ04879B

Morsetto C01 Versa
Jaw C01 Versa
Spannbacken C01 Versa
Étaux C01 Versa
Mordaza C01 Versa

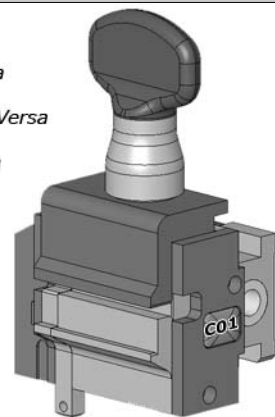

RIC05264B

Fresino V007
Cutter V007
Fräser V007
Fraise V007
Fresa V007

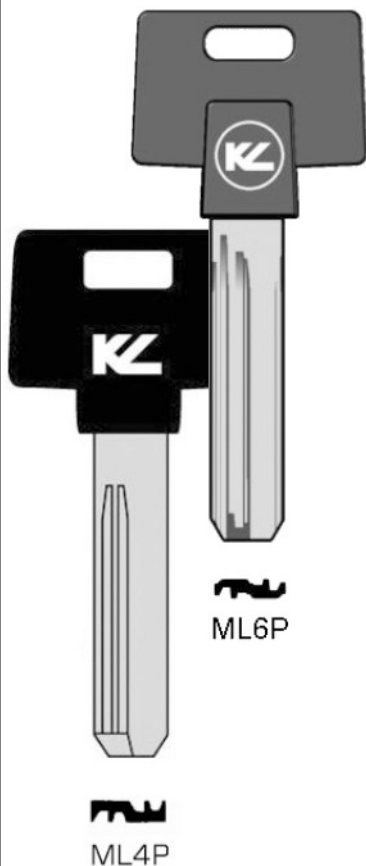

ML6P

ML4P

OPTIONAL

code

100°



0.4 mm

RIC05044B
Fresino V007
Cutter V007
Fräser V007
Fraise V007
Fresa V007



1.08 mm

RIC07782B
Fresino V035
Cutter V035
Fräser V035
Fraise V035
Fresa V035



OPZ08107B
Morsetto C15 Versa
Jaw C15 Versa
Spannbacken C15 Versa
Étaux C15 Versa
Mordaza C15 Versa

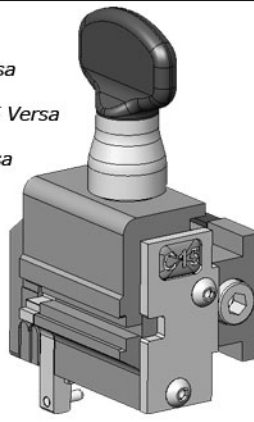

VERSA

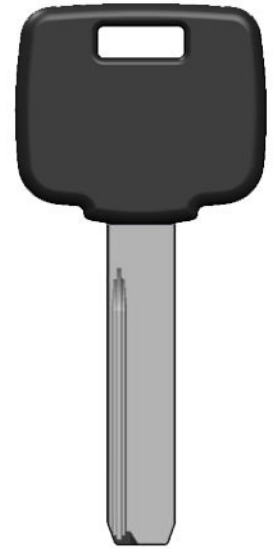
MT5
MT5+

OPTIONAL

CODE

OPZ08506B
Morsetto C22
Jaw C22
Spannbacken C22
Étaux C22
Mordaza C22

90°



0.4 mm

RIC05044B
Fresino V001
Cutter V001
Fräser V001
Fraise V001
Fresa V001



INCLUDED WITH JAW
Tastatore T005
Tracer Point T005
Taster T005
Palpeur T005
Palpador T005



VERSA



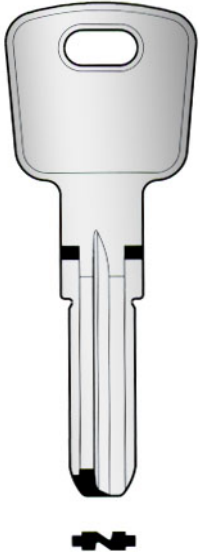

VERSA

STANDARD

code

90°



0.4 mm

RIC05044B
 Fresino V001
 Cutter V001
 Fräser V001
 Fraise V001
 Fresa V001



OPZ04879B
 Morsetto C01 Versa
 Jaw C01 Versa
 Spannbacke C01 Versa
 Étau C01 Versa
 Mordaza C01 Versa

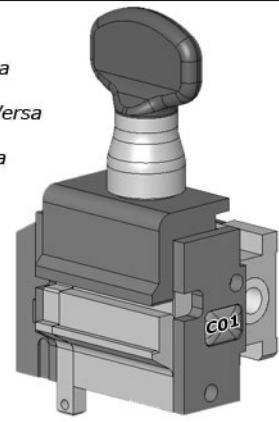

OPTIONAL

code

90°



0.7 mm

RIC05618B
 Fresino V013
 Cutter V013
 Fräser V013
 Fraise V013
 Fresa V013



82°



0.5 mm

RIC05084B
 Fresino V004
 Cutter V004
 Fräser V004
 Fraise V004
 Fresa V004

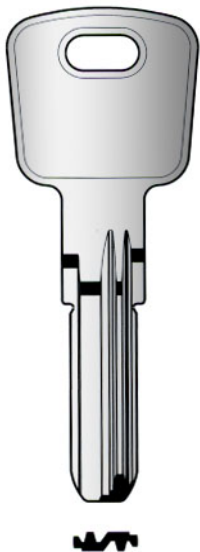

VERSA

STANDARD

code

82°



0.5 mm

RIC05084B
 Fresino V004
 Cutter V004
 Fräser V004
 Fraise V004
 Fresa V004



OPZ04879B
 Morsetto C01 Versa
 Jaw C01 Versa
 Spannbacken C01 Versa
 Étaux C01 Versa
 Mordaza C01 Versa

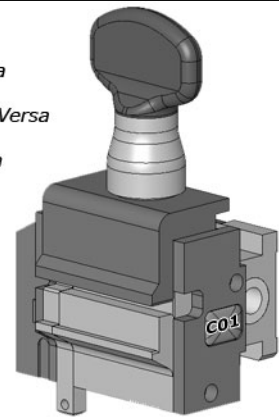

OPTIONAL

OPZ05807B

Morsetto C07 Versa con adattatori Pfaffenhein
Jaw C07 Versa with Pfaffenhein Adaptors
Spannbacken C07 Versa mit Pfaffenhein Adapter
Étaux C07 Versa avec adapteurs Pfaffenhein
Mordaza C07 Versa con adaptadores Pfaffenhein

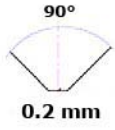

RIC05044B
Fresino V001
Cutter V001
Fräser V001
Fraise V001
Fresa V001

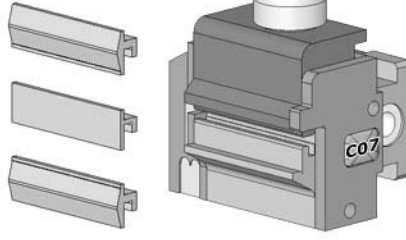

VERSA

K14 KV14



STANDARD



OPZ04879B

Morsetto C01 Versa
Jaw C01 Versa
Spannbacken C01 Versa
Étaux C01 Versa
Mordaza C01 Versa



RIC05044B
Fresino V001
Cutter V001
Fräser V001
Fraise V001
Fresa V001



RIC05618B
Fresino V013
Cutter V013
Fräser V013
Fraise V013
Fresa V013

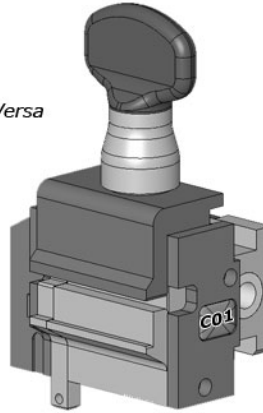

VERSA

INTEGRAL

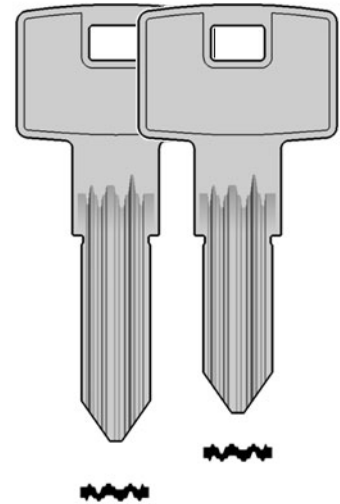

WAVYLINE

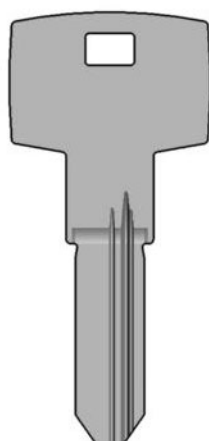

VERSA

OPTIONAL

CODE

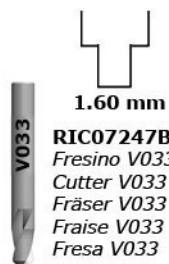

RIC07247B
 Fresino V033
 Cutter V033
 Fräser V033
 Fraise V033
 Fresa V033

OPZ07237B
 Morsetto C13 Versa
 Jaw C13 Versa
 Spannbacke C13 Versa
 Étau C13 Versa
 Mordaza C13 Versa

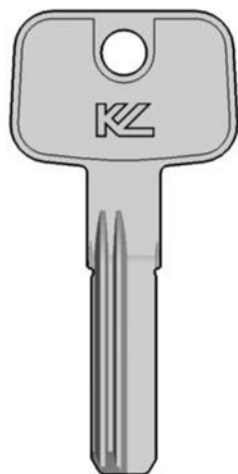
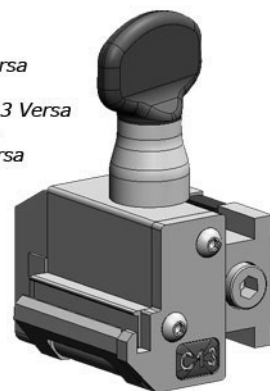

POT4



VERSA

STANDARD

code

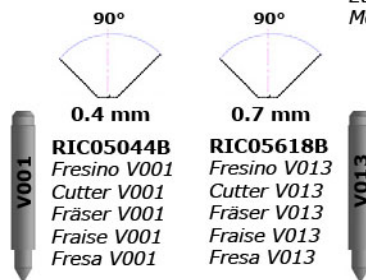

RIC05044B
 Fresino V001
 Cutter V001
 Fräser V001
 Fraise V001
 Fresa V001

RIC05618B
 Fresino V013
 Cutter V013
 Fräser V013
 Fraise V013
 Fresa V013

OPZ04879B
 Morsetto C01 Versa
 Jaw C01 Versa
 Spannbacken C01 Versa
 Étaux C01 Versa
 Mordaza C01 Versa

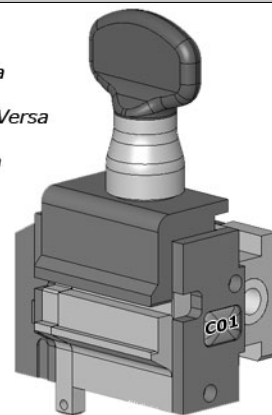

TO
FIT :

PREFER (I)



VERSA



PR8

TO
FIT :

SEA (CH)



VERSA

20 / 23

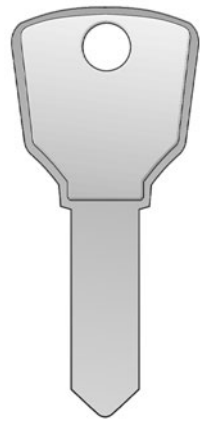

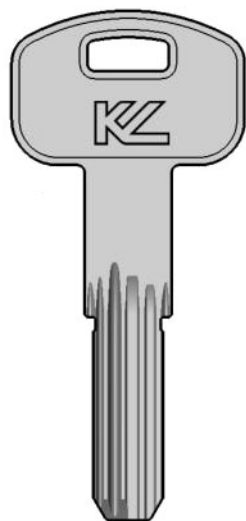

K1
SEC9

K2
SEC10



VERSA

STANDARD

code



RIC05044B
Fresino V001
Cutter V001
Fräser V001
Fraise V001
Fresa V001



RIC05618B
Fresino V013
Cutter V013
Fräser V013
Fraise V013
Fresa V013

OPZ04879B
Morsetto C01 Versa
Jaw C01 Versa
Spannbacken C01 Versa
Étaux C01 Versa
Mordaza C01 Versa

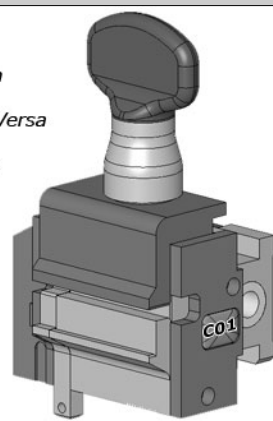

KYR1



VERSA

OPTIONAL

CODE



RIC05044B
Fresino V001
Cutter V001
Fräser V001
Fraise V001
Fresa V001

STANDARD

OPZ07800B
Morsetto C15 Versa
Jaw C15 Versa
Spannbacke C15 Versa
Étau C15 Versa
Mordaza C15 Versa

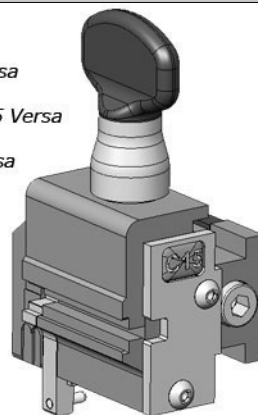

STANDARD



OPZ04879B
 Morsetto C01 Versa
 Jaw C01 Versa
 Spannbacken C01 Versa
 Étaux C01 Versa
 Mordaza C01 Versa

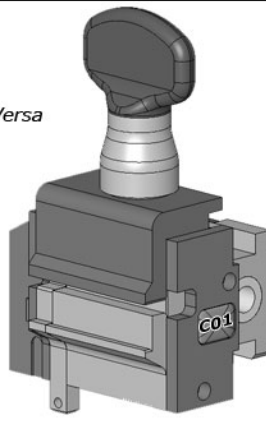

VERSA



 0.4 mm RIC05044B Fresino V001 Cutter V001 Fräser V001 Fraise V001 Fresa V001	 0.7 mm RIC05618B Fresino V013 Cutter V013 Fräser V013 Fraise V013 Fresa V013
--	--

STANDARD



OPZ04879B
 Morsetto C01 Versa
 Jaw C01 Versa
 Spannbacke C01 Versa
 Étau C01 Versa
 Mordaza C01 Versa

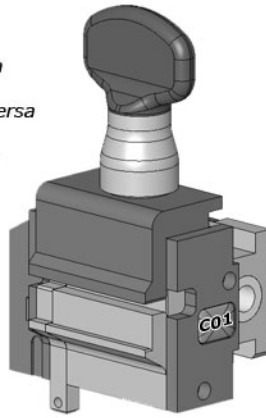

VERSA

X KEY
 NEW X-KEY



 0.4 mm RIC05044B Fresino V001 Cutter V001 Fräser V001 Fraise V001 Fresa V001
--

OPTIONAL



 0.7 mm RIC05618B Fresino V013 Cutter V013 Fräser V013 Fraise V013 Fresa V013	 0.6 mm RIC05612B Fresino V014 Cutter V014 Fräser V014 Fraise V014 Fresa V014
--	--

ORIGINAL



VERSA

STANDARD

code

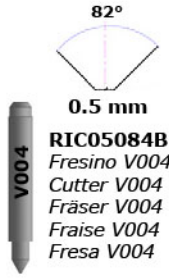

RIC05084B
Fresino V004
Cutter V004
Fräser V004
Fraise V004
Fresa V004

OPZ04879B

Morsetto C01 Versa
Jaw C01 Versa
Spannbacken C01 Versa
Étaux C01 Versa
Mordaza C01 Versa

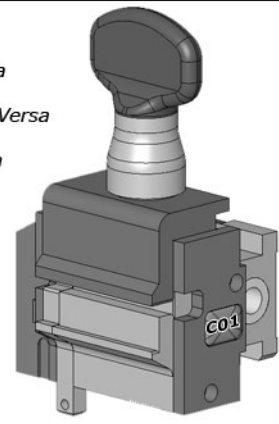

SPD1 SPD1S



VERSA

STANDARD

code

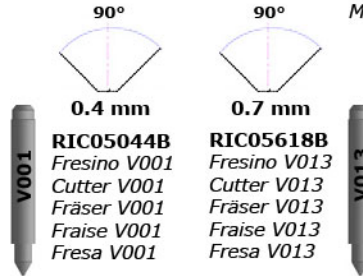

RIC05044B
Fresino V001
Cutter V001
Fräser V001
Fraise V001
Fresa V001

RIC05618B
Fresino V013
Cutter V013
Fräser V013
Fraise V013
Fresa V013

OPZ04879B

Morsetto C01 Versa
Jaw C01 Versa
Spannbacken C01 Versa
Étaux C01 Versa
Mordaza C01 Versa

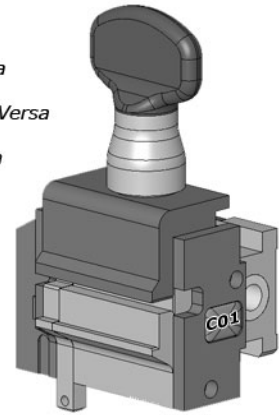

STANDARD

code

OPZ04879B
 Morsetto C01 Versa
 Jaw C01 Versa
 Spannbacken C01 Versa
 Étaux C01 Versa
 Mordaza C01 Versa

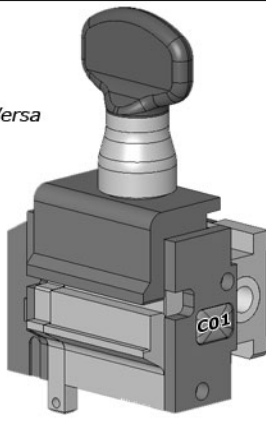

VERSA

STS MINI
MEGA 6

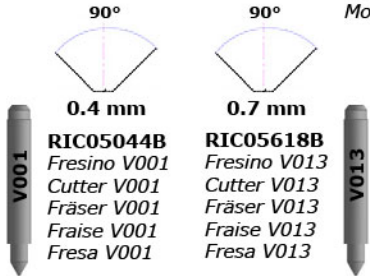

RIC05044B
 Fresino V001
 Cutter V001
 Fräser V001
 Fraise V001
 Fresa V001

RIC05618B
 Fresino V013
 Cutter V013
 Fräser V013
 Fraise V013
 Fresa V013



STS66

STANDARD

code

OPZ04879B
 Morsetto C01 Versa
 Jaw C01 Versa
 Spannbacken C01 Versa
 Étaux C01 Versa
 Mordaza C01 Versa

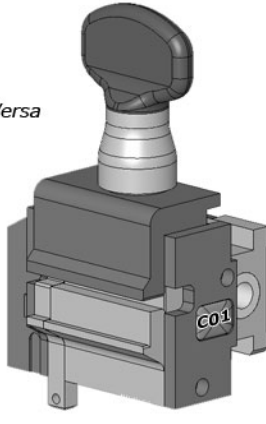

VERSA

CS

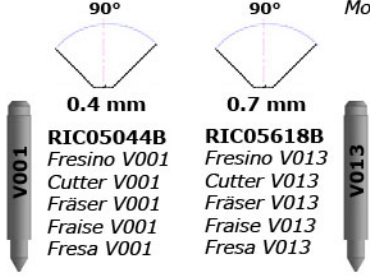

RIC05044B
 Fresino V001
 Cutter V001
 Fräser V001
 Fraise V001
 Fresa V001

RIC05618B
 Fresino V013
 Cutter V013
 Fräser V013
 Fraise V013
 Fresa V013



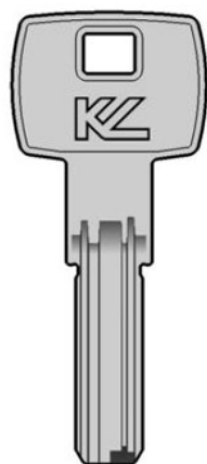

MR11



VERSA

STANDARD

code



0.4 mm
RIC05044B
 Fresino V001
 Cutter V001
 Fräser V001
 Fraise V001
 Fresa V001



0.7 mm
RIC05618B
 Fresino V013
 Cutter V013
 Fräser V013
 Fraise V013
 Fresa V013

OPZ04879B
 Morsetto C01 Versa
 Jaw C01 Versa
 Spannbacken C01 Versa
 Étaux C01 Versa
 Mordaza C01 Versa

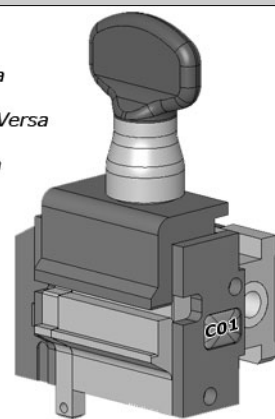

TAR7 TAR7S



VERSA

STANDARD

code



0.4 mm
RIC05044B
 Fresino V001
 Cutter V001
 Fräser V001
 Fraise V001
 Fresa V001



0.7 mm
RIC05618B
 Fresino V013
 Cutter V013
 Fräser V013
 Fraise V013
 Fresa V013

OPZ04879B
 Morsetto C01 Versa
 Jaw C01 Versa
 Spannbacken C01 Versa
 Étaux C01 Versa
 Mordaza C01 Versa

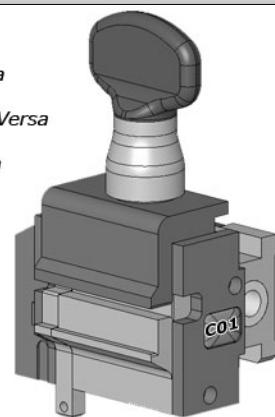

STANDARD



OPZ04879B
 Morsetto C01 Versa
 Jaw C01 Versa
 Spannbacken C01 Versa
 Étaux C01 Versa
 Mordaza C01 Versa

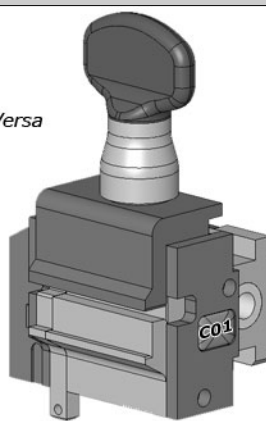

VERSA



0.5 mm

RIC05084B
 Fresino V004
 Cutter V004
 Fräser V004
 Fraise V004
 Fresa V004

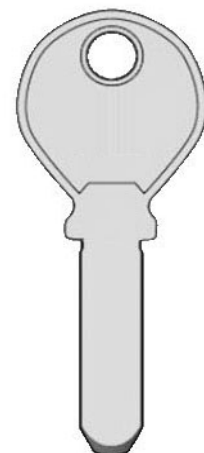

→ KESO

STANDARD



OPZ04879B
 Morsetto C01 Versa
 Jaw C01 Versa
 Spannbacken C01 Versa
 Étaux C01 Versa
 Mordaza C01 Versa

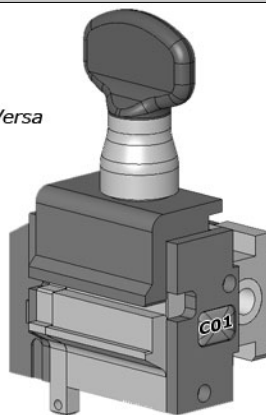

VERSA

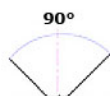

0.4 mm

RIC05044B
 Fresino V001
 Cutter V001
 Fräser V001
 Fraise V001
 Fresa V001

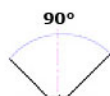

0.7 mm

RIC05618B
 Fresino V013
 Cutter V013
 Fräser V013
 Fraise V013
 Fresa V013

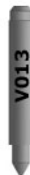

T60 / T80



TES7 TES4



TX70 / TX80



MLFN



VERSA

STANDARD

code



0.4 mm



RIC05044B
Fresino V001
Cutter V001
Fräser V001
Fraise V001
Fresa V001

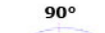

0.7 mm



RIC05618B
Fresino V013
Cutter V013
Fräser V013
Fraise V013
Fresa V013

OPZ04879B
Morsetto C01 Versa
Jaw C01 Versa
Spannbacken C01 Versa
Étaux C01 Versa
Mordaza C01 Versa

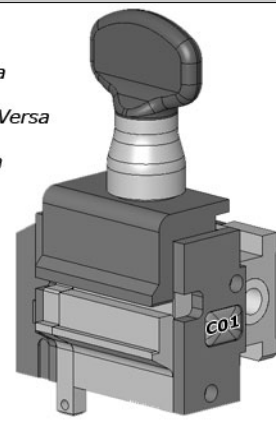

TIN7



VERSA

STANDARD

code

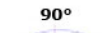

0.4 mm



RIC05044B
Fresino V001
Cutter V001
Fräser V001
Fraise V001
Fresa V001

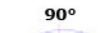

0.7 mm



RIC05618B
Fresino V013
Cutter V013
Fräser V013
Fraise V013
Fresa V013

OPZ04879B
Morsetto C01 Versa
Jaw C01 Versa
Spannbacken C01 Versa
Étaux C01 Versa
Mordaza C01 Versa

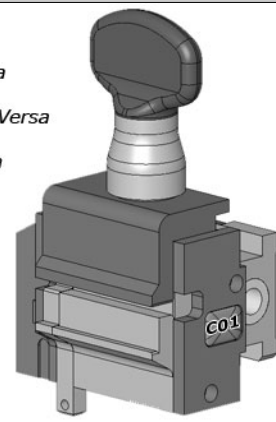

OPTIONAL

code

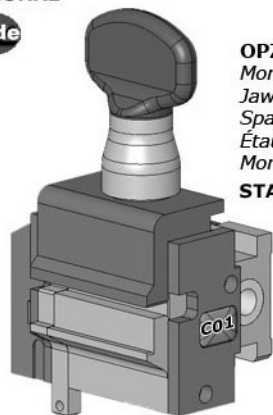

OPZ04879B
 Morsetto C01 Versa
 Jaw C01 Versa
 Spannbacke C01 Versa
 Étau C01 Versa
 Mordaza C01 Versa

STANDARD



RIC05266B
 Fresino V008
 Cutter V008
 Fräser V008
 Fraise V008
 Fresa V008

106°

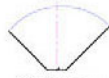

0.4 mm



VERSA

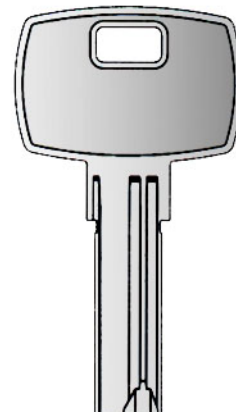

STANDARD

code

90°



0.4 mm



RIC05044B
 Fresino V001
 Cutter V001
 Fräser V001
 Fraise V001
 Fresa V001

OPZ04879B
 Morsetto C01 Versa
 Jaw C01 Versa
 Spannbacke C01 Versa
 Étau C01 Versa
 Mordaza C01 Versa

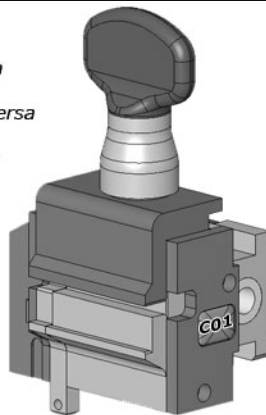

VERSA

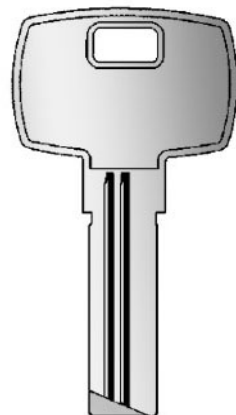

OPTIONAL

code

90°



0.7 mm

RIC05618B
 Fresino V013
 Cutter V013
 Fräser V013
 Fraise V013
 Fresa V013



90°



0.6 mm

RIC05612B
 Fresino V014
 Cutter V014
 Fräser V014
 Fraise V014
 Fresa V014



2000

ORIGINAL



VERSA

STANDARD

code

100°



0.4 mm

OPZ04879B

Morsetto C01 Versa
Jaw C01 Versa
Spannbacken C01 Versa
Étaux C01 Versa
Mordaza C01 Versa

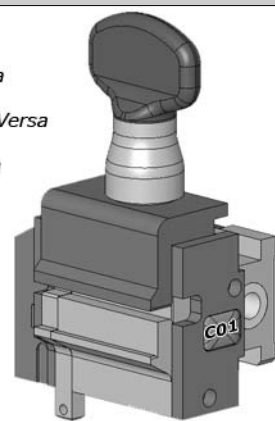

RIC05264B

Fresino V007
Cutter V007
Fräser V007
Fraise V007
Fresa V007



VERSA

STANDARD

code

100°



0.4 mm

OPZ04879B

Morsetto C01 Versa
Jaw C01 Versa
Spannbacken C01 Versa
Étaux C01 Versa
Mordaza C01 Versa

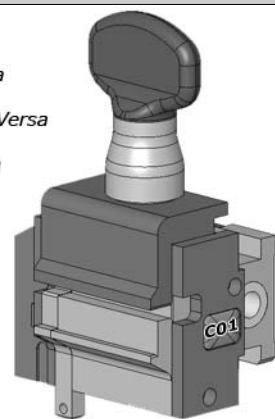

RIC05264B

Fresino V007
Cutter V007
Fräser V007
Fraise V007
Fresa V007

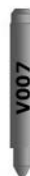

STANDARD



OPZ04879B
 Morsetto C01 Versa
 Jaw C01 Versa
 Spannbacken C01 Versa
 Étaux C01 Versa
 Mordaza C01 Versa

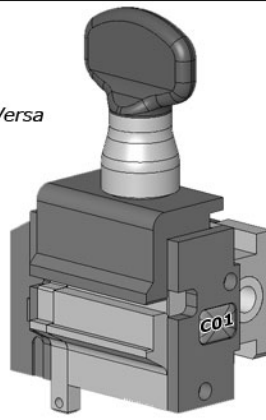

VERSA

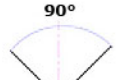

0.4 mm

RIC05044B
 Fresino V001
 Cutter V001
 Fräser V001
 Fraise V001
 Fresa V001

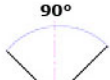

0.7 mm

RIC05618B
 Fresino V013
 Cutter V013
 Fräser V013
 Fraise V013
 Fresa V013



STANDARD



OPZ04879B
 Morsetto C01 Versa
 Jaw C01 Versa
 Spannbacken C01 Versa
 Étaux C01 Versa
 Mordaza C01 Versa

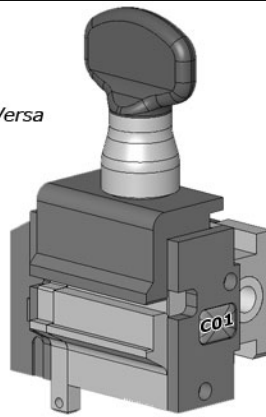

VERSA

EURO-PRO

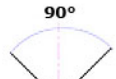
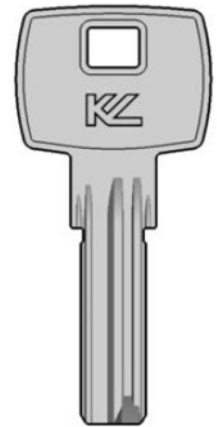

0.4 mm

RIC05044B
 Fresino V001
 Cutter V001
 Fräser V001
 Fraise V001
 Fresa V001

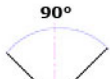

0.7 mm

RIC05618B
 Fresino V013
 Cutter V013
 Fräser V013
 Fraise V013
 Fresa V013



ORIGINAL



VERSA

STANDARD

code

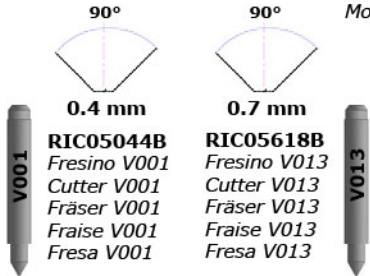

RIC05044B
 Fresino V001
 Cutter V001
 Fräser V001
 Fraise V001
 Fresa V001

RIC05618B
 Fresino V013
 Cutter V013
 Fräser V013
 Fraise V013
 Fresa V013

OPZ04879B
 Morsetto C01 Versa
 Jaw C01 Versa
 Spannbacken C01 Versa
 Étaux C01 Versa
 Mordaza C01 Versa

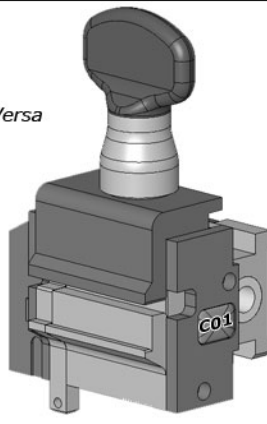

ORIGINAL

P3/PR300



VERSA

OPTIONAL

code



RIC05044B
 Fresino V001
 Cutter V001
 Fräser V001
 Fraise V001
 Fresa V001

OPZ08375B
 Morsetto C19
 Jaw C19
 Spannbacke C19
 Étau C19
 Mordaza C19

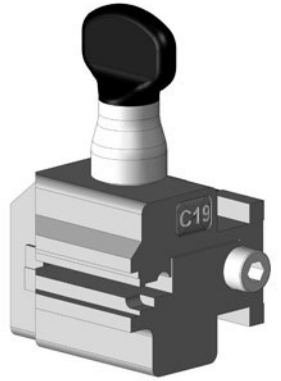

STANDARD



OPZ04879B
 Morsetto C01 Versa
 Jaw C01 Versa
 Spannbacken C01 Versa
 Étaux C01 Versa
 Mordaza C01 Versa

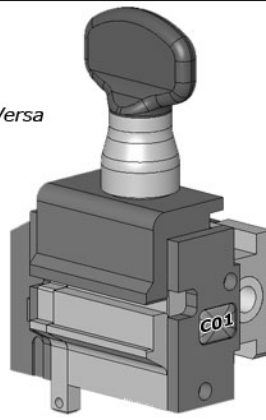

VERSA

W3600

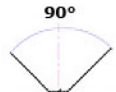

0.4 mm

RIC05044B

Fresino V001
 Cutter V001
 Fräser V001
 Fraise V001
 Fresa V001



0.7 mm

RIC05618B

Fresino V013
 Cutter V013
 Fräser V013
 Fraise V013
 Fresa V013



STANDARD



OPZ04879B
 Morsetto C01 Versa
 Jaw C01 Versa
 Spannbacken C01 Versa
 Étaux C01 Versa
 Mordaza C01 Versa

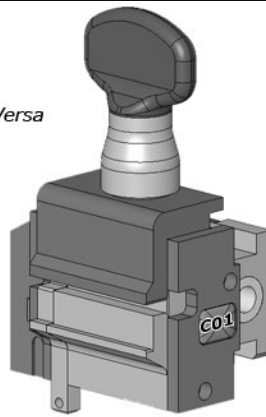

VERSA

X-TRA

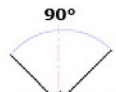
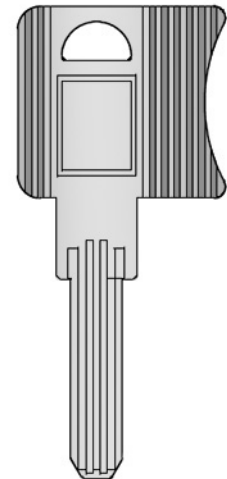

0.4 mm

RIC05044B

Fresino V001
 Cutter V001
 Fräser V001
 Fraise V001
 Fresa V001

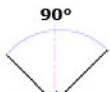

0.7 mm

RIC05618B

Fresino V013
 Cutter V013
 Fräser V013
 Fraise V013
 Fresa V013



MARTE



VERSA

STANDARD

code



0.4 mm



RIC05044B
Fresino V001
Cutter V001
Fräser V001
Fraise V001
Fresa V001



0.7 mm



RIC05618B
Fresino V013
Cutter V013
Fräser V013
Fraise V013
Fresa V013

OPZ04879B
Morsetto C01 Versa
Jaw C01 Versa
Spannbacken C01 Versa
Étaux C01 Versa
Mordaza C01 Versa

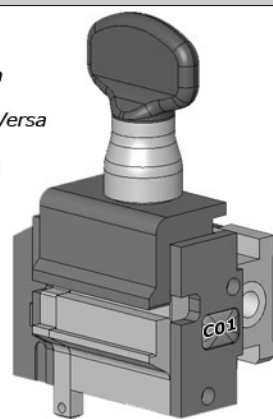

ORIGINAL



VERSA

STANDARD

code

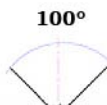

0.4 mm



RIC05264B
Fresino V007
Cutter V007
Fräser V007
Fraise V007
Fresa V007

OPZ04879B
Morsetto C01 Versa
Jaw C01 Versa
Spannbacken C01 Versa
Étaux C01 Versa
Mordaza C01 Versa

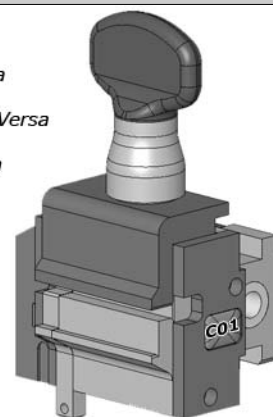

YY3P



YY5P

STANDARD

code

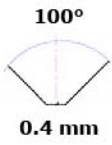

RIC05264B
Fresino V007
Cutter V007
Fräser V007
Fraise V007
Fresa V007

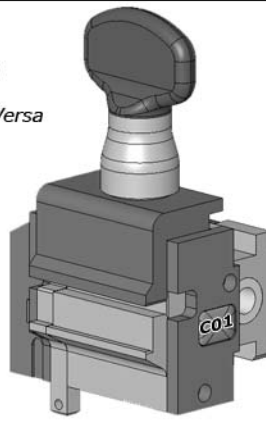

OPZ04879B
Morsetto C01 Versa
Jaw C01 Versa
Spannbacken C01 Versa
Étaux C01 Versa
Mordaza C01 Versa



VERSA

XL

YY13P

CHIAVI AUTO / CHIAVI CAMION / ACCESSORI

CAR KEYS / TRUCK KEYS / ACCESSORIES

AUTOSCHLÜSSEL / LKW-SCHLÜSSEL / ZUBEHÖR

CLÉS AUTO / CLÉS CAMION / ACCESSOIRES

LLAVES PARA AUTO / LLAVES PARA CAMIONES / ACCESORIOS



STANDARD



RIC05048B
Fresino V003
Cutter V003
Fräser V003
Fresa V003

OPZ04875B
Morsetto A03 Versa
Jaw A03 Versa
Spannbacken A03 Versa
Étaux A03 Versa
Mordaza A03 Versa

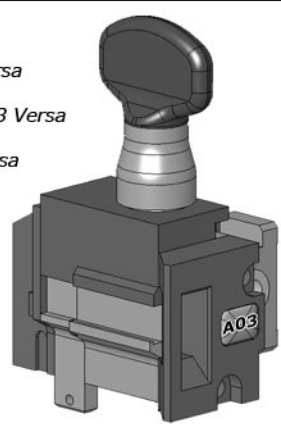

VERSA

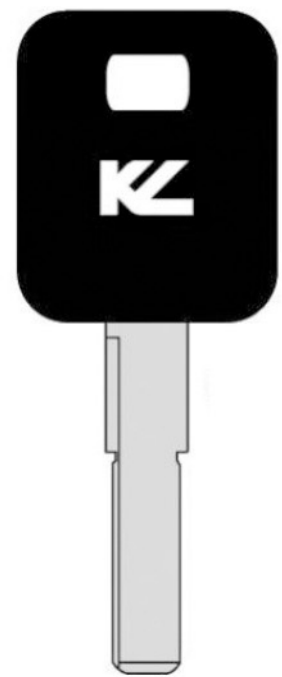

 AD66TK1

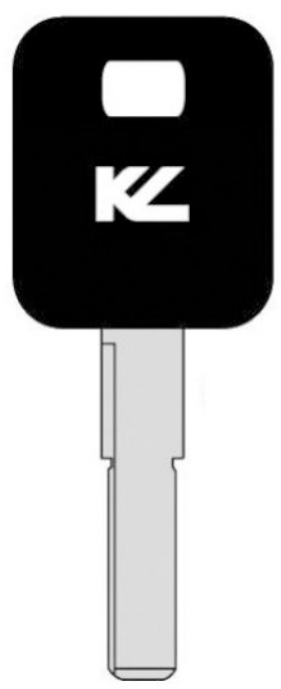

 AD66TK8

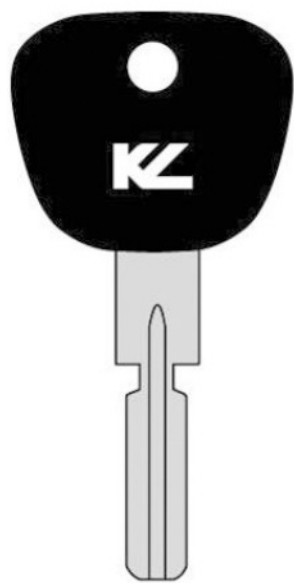

HU58P



VERSA

STANDARD

code



2.5 mm



OPZ04873B

Morsetto A02 Versa
Jaw A02 Versa
Spannbacken A02 Versa
Étaux A02 Versa
Mordaza A02 Versa

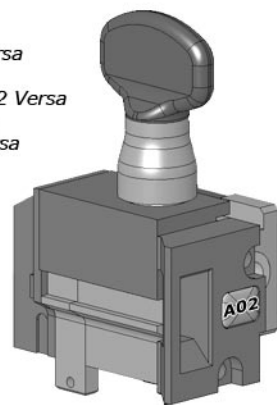

RIC05048B

Fresino V003
Cutter V003
Fräser V003
Fresa V003

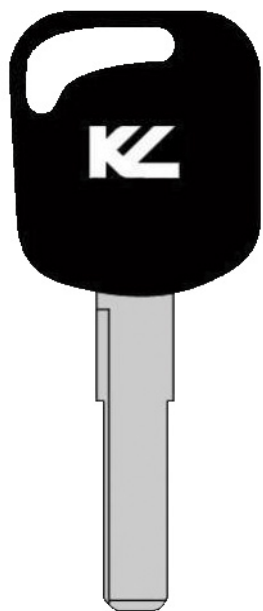

FD66TK1



VERSA

STANDARD

code



2.5 mm



OPZ04875B

Morsetto A03 Versa
Jaw A03 Versa
Spannbacken A03 Versa
Étaux A03 Versa
Mordaza A03 Versa

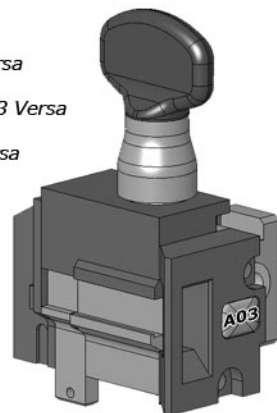

RIC05048B

Fresino V003
Cutter V003
Fräser V003
Fresa V003

STANDARD



2.5 mm



RIC05048B
Fresino V003
Cutter V003
Fräser V003
Fresa V003

OPZ04871B
Morsetto A01 Versa
Jaw A01 Versa
Spannbacken A01 Versa
Étaux A01 Versa
Mordaza A01 Versa

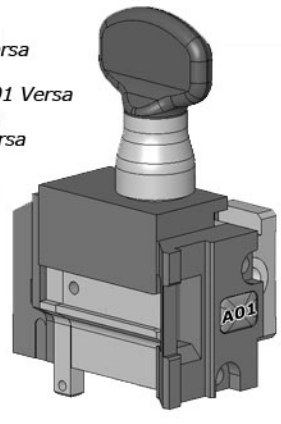

VERSA



FD40TK14



FD40AP



HD1TK5



VERSA

STANDARD

code



2.5 mm



OPZ04871B

Morsetto A01 Versa
Jaw A01 Versa
Spannbacken A01 Versa
Étaux A01 Versa
Mordaza A01 Versa

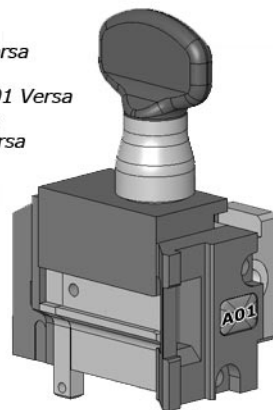

RIC05048B

Fresino V003
Cutter V003
Fräser V003
Fresa V003

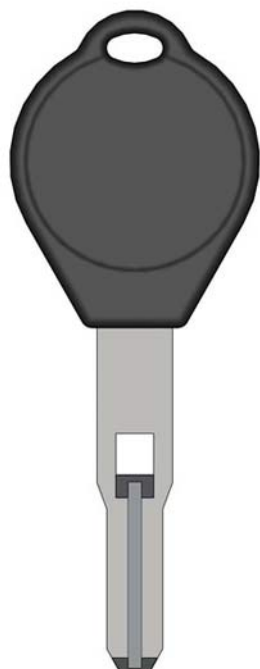

H



VERSA

OPTIONAL

code



RIC05048B

Fresino V003
Cutter V003
Fräser V003
Fraise V003
Fresa V003



2.5 mm

OPZ04871B

Morsetto A01 Versa
Jaw A01 Versa
Spannbacken A01 Versa
Étaux A01 Versa
Mordaza A01 Versa

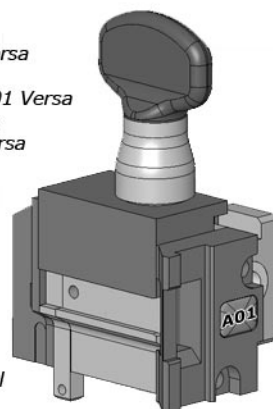

OPZ05493B

Adattatore AV01 per chiavi Infiniti
Adaptor AV01 for Infiniti keys
Spannbacken AV01 für Infiniti-Schlüssel
Étaux AV01 pou clés Infiniti
Mordaza AV01 para llaves Infiniti

STANDARD

code



2.5 mm



RIC05048B
Fresino V003
Cutter V003
Fräser V003
Fresa V003

OPZ04871B
Morsetto A01 Versa
Jaw A01 Versa
Spannbacken A01 Versa
Étaux A01 Versa
Mordaza A01 Versa

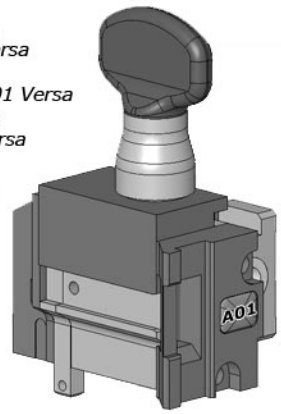

VERSA

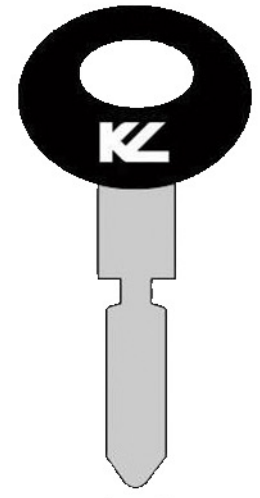

MB53P

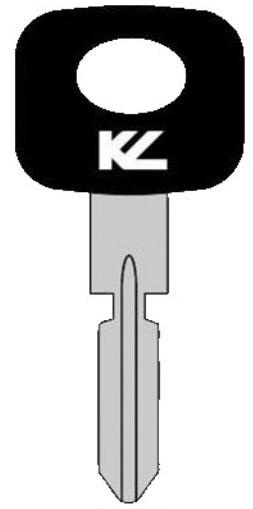

MB52P

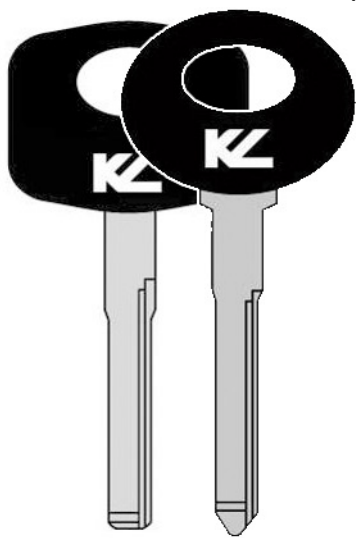

MB57P

MB54P

MB41P

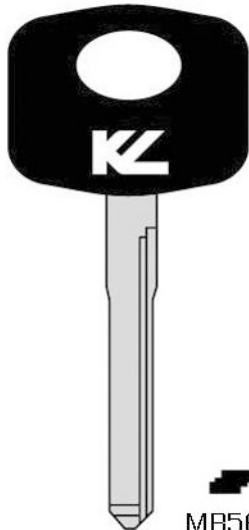

MB56P

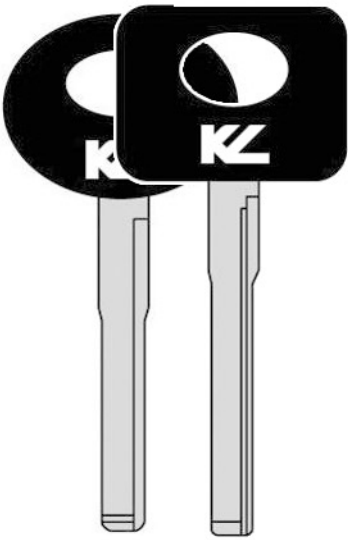

MB58P

MB55P

MB59P



VERSA

OPTIONAL

code



2.5 mm



RIC05048B

Fresino V003
Cutter V003
Fräser V003
Fresa V003

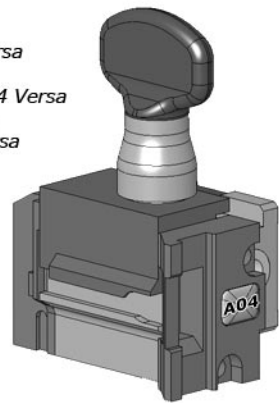

OPZ04877B

Morsetto A04 Versa
Jaw A04 Versa
Spannbacken A04 Versa
Étaux A04 Versa
Mordaza A04 Versa

STANDARD

code



2.5 mm



RIC05048B
Fresino V003
Cutter V003
Fräser V003
Fresa V003

OPZ04871B
Morsetto A01 Versa
Jaw A01 Versa
Spannbacken A01 Versa
Étaux A01 Versa
Mordaza A01 Versa

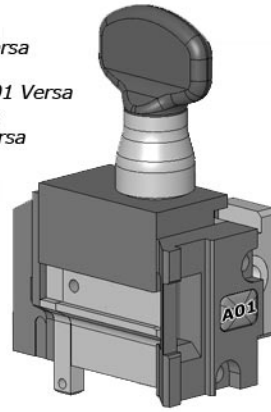

VERSA







VX4TK12	VX4P
VX4TK5	VX3P



VX3TK5



-  
VX4TK12 VX4P
-  
VX4TK5 VX3P
- 
VX3TK5



VX5TK12



VERSA

STANDARD

code



2.5 mm



RIC05048B
*Fresino V003
 Cutter V003
 Fräser V003
 Fresa V003*

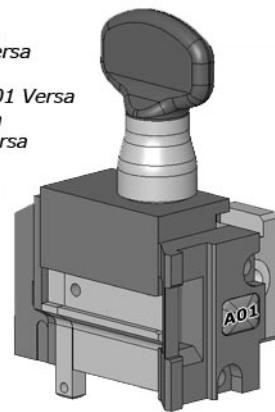

OPZ04871B
*Morsetto A01 Versa
 Jaw A01 Versa
 Spannbacken A01 Versa
 Étaux A01 Versa
 Mordaza A01 Versa*

STANDARD

code



2.5 mm



RIC05048B
Fresino V003
Cutter V003
Fräser V003
Fresa V003

OPZ04873B
Morsetto A02 Versa
Jaw A02 Versa
Spannbacken A02 Versa
Étaux A02 Versa
Mordaza A02 Versa

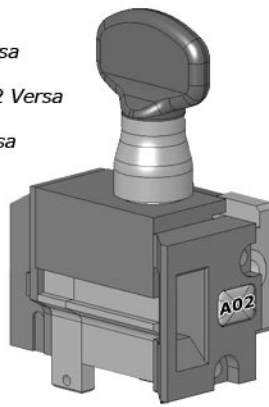

VERSA



PG31TK1

OPTIONAL

code

OPZ05345B
Adattatore AV02 per chiavi Renault
Adaptor AV02 for Renault keys
Spannbacken AV02 für Renault-Schlüssel
Étaux AV02 pou clés Renault
Mordaza AV02 para llaves Renault



2.5 mm



RIC05048B
Fresino V003
Cutter V003
Fräser V003
Fresa V003

OPZ04875B
Morsetto A03 Versa
Jaw A03 Versa
Spannbacken A03 Versa
Étaux A03 Versa
Mordaza A03 Versa

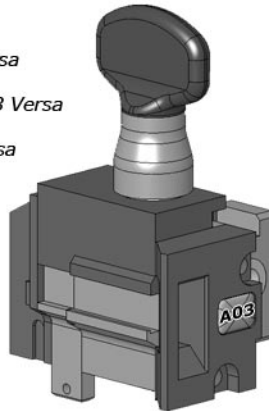

VERSA

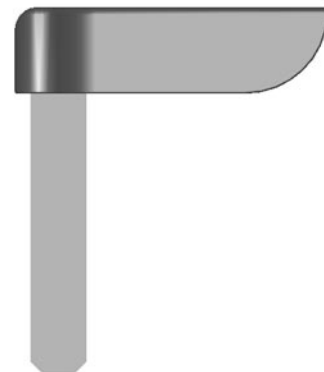



V66TK1



V66TK8



VERSA

STANDARD

code



2.5 mm

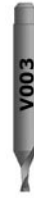

OPZ04875B

- Morsetto A03 Versa*
- Jaw A03 Versa*
- Spannbacken A03 Versa*
- Étaux A03 Versa*
- Mordaza A03 Versa*

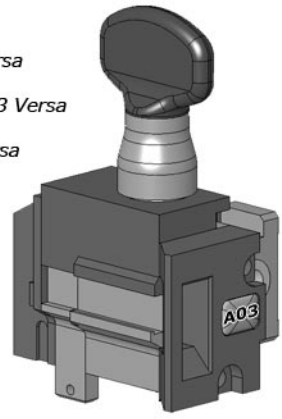

RIC05048B

- Fresino V003*
- Cutter V003*
- Fräser V003*
- Fresa V003*

STANDARD



2.5 mm



RIC05048B
Fresino V003
Cutter V003
Fräser V003
Fresa V003

OPZ04875B
Morsetto A03 Versa
Jaw A03 Versa
Spannbacken A03 Versa
Étaux A03 Versa
Mordaza A03 Versa

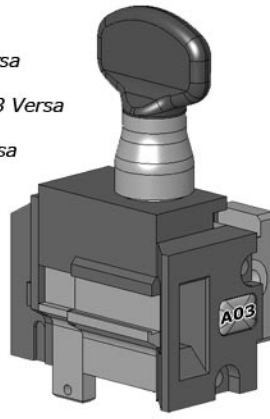

VERSA

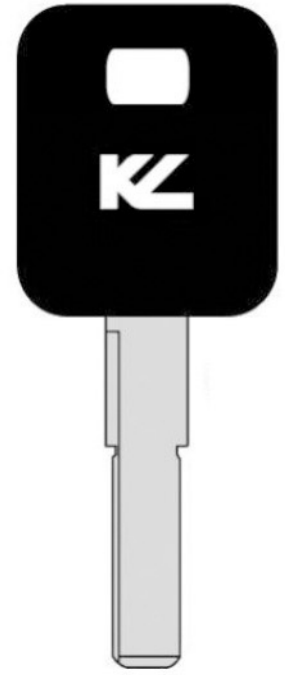

AD66TK1

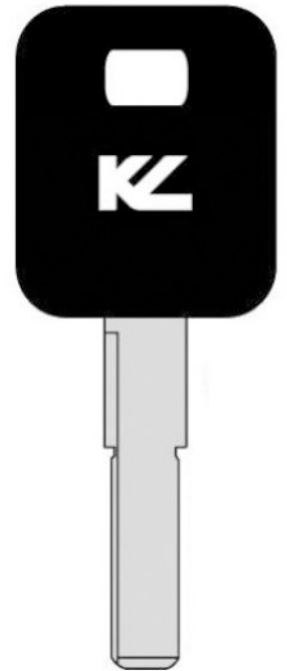

AD66TK8



TR48BTK3 TR49P



TR49BTK3



VERSA

STANDARD

code



2.5 mm



RIC05048B
Fresino V003
Cutter V003
Fräser V003
Fresa V003

OPZ04871B
Morsetto A01 Versa
Jaw A01 Versa
Spannbacken A01 Versa
Étaux A01 Versa
Mordaza A01 Versa

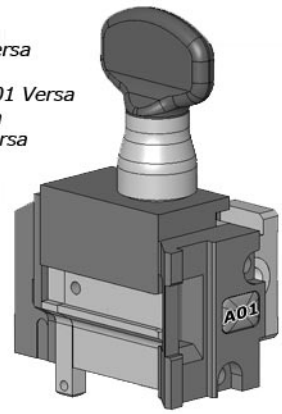

STANDARD



2.5 mm



OPZ04875B
 Morsetto A03 Versa
 Jaw A03 Versa
 Spannbacken A03 Versa
 Étaux A03 Versa
 Mordaza A03 Versa

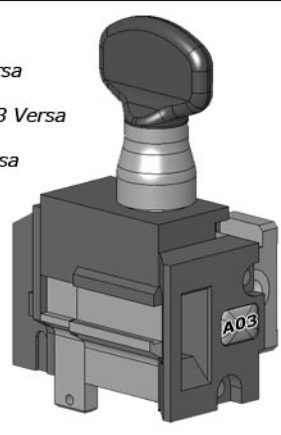

RIC05048B
 Fresino V003
 Cutter V003
 Fräser V003
 Fresa V003



VERSA



V66TK1



V66TK8

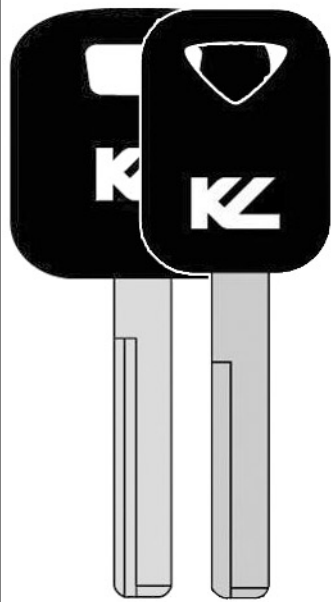

VL15TK1 VL16P

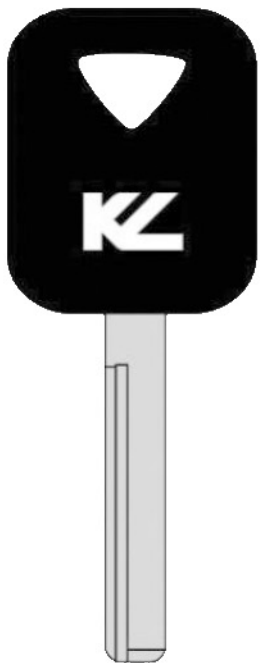

VL15P



VERSA

STANDARD

code



2.5 mm

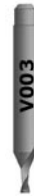

RIC05048B
Fresino V003
Cutter V003
Fräser V003
Fresa V003

OPZ04873B
Morsetto A02 Versa
Jaw A02 Versa
Spannbacken A02 Versa
Étaux A02 Versa
Mordaza A02 Versa

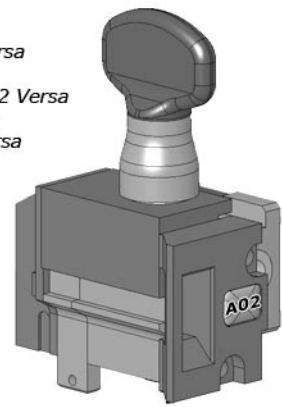

STANDARD

code



2.5 mm



RIC05048B
Fresino V003
Cutter V003
Fräser V003
Fresa V003

OPZ04871B
Morsetto A01 Versa
Jaw A01 Versa
Spannbacken A01 Versa
Étaux A01 Versa
Mordaza A01 Versa

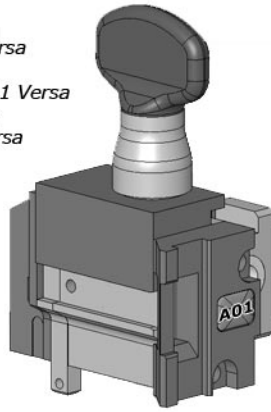

VERSA

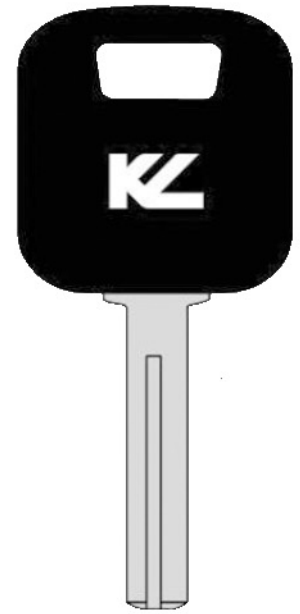

VL17TK1



VL17P



VL18P

ACCESSORI GENERICI OPZIONALI

OPTIONAL GENERIC ACCESSORIES

OPTIONAL ALLGEMEINE ZUBEHÖRE

ACCESSOIRES VARIÉS OPTIONAUX

ACCESORIOS GENÉRICOS OPCIONALES



**OPZ06039B**

Morsetto C08 per chiavi piatte
Jaw C08 for edge-cut keys
Spannbacke C08 für Flachschlüssel
Étau C08 pour clés plates
Mordaza C08 para llaves planas

**OPZ06377B**

Tastatore T003
Tracer T003
Taster T003
Palpeur T003
Palpador T003



VERSA