

**Additional Information**

- Standard load: Maximum door weight 100 kg (per pair)  
 Application: Concealed hinge for non-rebated doors, hinge leaves are mortised into frame and door; 3-dimensional adjustability, maintenance-free bearings;  
 Accessories: PIVOTA® DX safety plate for frame part, retainer for casing or steel frames  
 Note: incl. fixing screws

**Section Drawing**

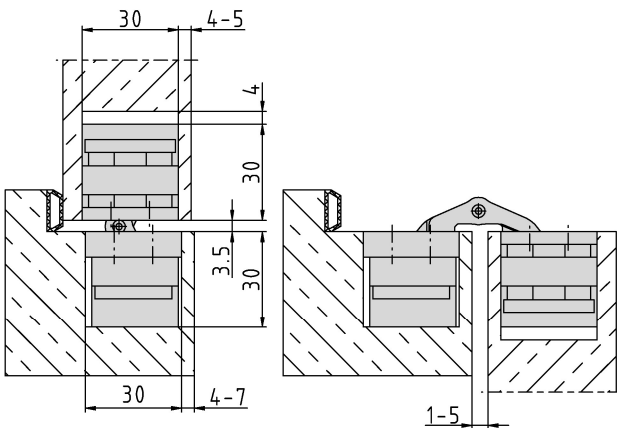

Certified according to



Item	Finish	PU
037915	satin nickel plated	2
039429	Alu Look F1	2
040595	simulated SS	2